

CONTENTS

MedCaster Inc. is focused on the manufacturing and supply of casters and wheels to the Medical and Pharmaceutical industries. Our broad line of products and expertise allows us to meet our customer's needs. MedCaster can also design and produce casters and wheels that meet your specific requirements such as custom colors or other specifications. Please contact us toll free at 1-866-462-9700 or email us at info@medcaster.com.

| | |
|---------------------------------------|-----|
| CASTER FITTING GUIDE..... | 4-5 |
| MEDCASTER MODEL NUMBERING SYSTEM..... | 6 |

DOUBLE WHEEL CASTERS

| | |
|-------------------------------------|-------|
| DUAL WHEEL CASTERS (DW)..... | 7 |
| TWIN WHEEL CASTERS (TW) | 8 |
| NEW! GREY TECH CASTERS (GT)..... | 9 |
| MEDIMASTER (MM) | 10 |
| NEW! NON-MAGNETIC CASTERS (NM)..... | 11 |
| TWIN-MED (TM)..... | 12-13 |
| KICK-STOP (KS) | 14 |
| NEW! NEOTEQ CHROME DUAL (DN)..... | 15 |

MEDCASTER MULTI-PURPOSE CASTERS

| | |
|----------------------------------------------|-------|
| NEOTEQ (CN) | 16-17 |
| NEW! RAZER (RZ)..... | 18-21 |
| CHROME HOSPITAL (CH) | 22-33 |
| CHROME STEEL (CS) | 34-43 |
| STAINLESS STEEL (SS) 1-1/4" TREAD WIDTH..... | 44-49 |
| STAINLESS STEEL (SS) 2" DIAMETER | 50-52 |

MEDCASTER NYLON/PLASTIC CASTERS

| | |
|-------------------------------------------------------|-------|
| NYLON (NG) LIGHT GREY (ND) DARK GREY (NB) BLACK | 53-65 |
| NYLON PLUS STAINLESS (NS) | 66-73 |
| PLASTIC (PG)..... | 74-81 |
| PLASTIC ANTISTATIC (PA) | 82-83 |

MEDCASTER HOSPITAL BED CASTERS

| | |
|--------------------------------------------------------|-------|
| HOSPITAL BED CASTER INTRODUCTION AND ACCESSORIES | 84 |
| MED-BED (MB) | 85 |
| HOSPITAL BED PLASTIC (HP) | 86-87 |
| HOSPITAL BED CHROME (HC) | 88-89 |
| HOSPITAL BED STAINLESS STEEL (HS) | 90-91 |
| NEW! MED-ULTRA (MU)..... | 92 |

MEDCASTER SPECIALTY CASTERS & ACCESSORIES

| | |
|----------------------------------------------|-------|
| SOLUS TECH (ST)..... | 93 |
| WHEELS | 94-96 |
| WHEEL CHAIR CASTER (WC) (WW) | 97 |
| BUMPERS..... | 98 |
| SPECIALTY / INCHES TO METRIC CONVERSION..... | 99 |



CASTER FITTINGS GUIDE



HOLLOW KINGPIN

| Suffix No. | Dimensions | DW | CN | CH | CS | SS | NG | NS | PG | PA | RZ |
|------------|------------|----|----|----|----|----|----|----|----|----|----|
| HK01 | 1/2 ID | ✓ | | ✓ | ✓ | ✓ | ✓ | ✓ | ✓ | ✓ | |
| HK02 | 12mm ID | | | | | | | | ✓ | | |
| HK04 | 7/16 ID | | ✓ | | | | | | | | ✓ |



EXPANDING ADAPTER STEMS

| Suffix No. | Dimensions | CH | CS | SS | NG | NS | PG | PA |
|------------|------------|----|----|----|----|----|----|----|
|------------|------------|----|----|----|----|----|----|----|

Round Nylon Expanding Adapters

| | | | | | | | | |
|------|-------------------|---|---|---|---|---|---|---|
| XRN1 | 3/4 x 2-1/4 | ✓ | ✓ | ✓ | ✓ | ✓ | ✓ | ✓ |
| XRN2 | 13/16 x 2-1/4 | ✓ | ✓ | ✓ | ✓ | ✓ | ✓ | ✓ |
| XRN3 | 7/8 x 2-1/4 round | ✓ | ✓ | ✓ | ✓ | ✓ | ✓ | ✓ |
| XRN4 | 1 x 2-1/4 | ✓ | ✓ | ✓ | ✓ | ✓ | ✓ | ✓ |

Round Rubber Expanding Adapters

| | | | | | | | | |
|------|---------------|---|---|---|---|---|---|---|
| XRR1 | 3/4 x 2-1/4 | ✓ | ✓ | ✓ | ✓ | ✓ | ✓ | ✓ |
| XRR2 | 7/8 x 2-1/4 | ✓ | ✓ | ✓ | ✓ | ✓ | ✓ | ✓ |
| XRR3 | 1 x 2-1/4 | ✓ | ✓ | ✓ | ✓ | ✓ | ✓ | ✓ |
| XRR4 | 1-1/8 x 2-1/4 | ✓ | ✓ | ✓ | ✓ | ✓ | ✓ | ✓ |
| XRR5 | 1-1/4 x 2-1/4 | ✓ | ✓ | ✓ | ✓ | ✓ | ✓ | ✓ |
| XRR6 | 1-3/8 x 2-1/4 | ✓ | ✓ | ✓ | ✓ | ✓ | ✓ | ✓ |
| XRR7 | 1-1/2 x 2-1/4 | ✓ | ✓ | ✓ | ✓ | ✓ | ✓ | ✓ |
| XRR8 | 1-5/8 x 2-1/4 | ✓ | ✓ | ✓ | ✓ | ✓ | ✓ | ✓ |

Round Zamac Expanding Adapters

| | | | | | | | | |
|------|----------------|---|---|--|---|---|---|---|
| XRZ1 | 21/32 x 2-1/4 | ✓ | ✓ | | ✓ | ✓ | ✓ | ✓ |
| XRZ2 | 3/4 x 2-1/4 | ✓ | ✓ | | ✓ | ✓ | ✓ | ✓ |
| XRZ3 | 7/8 x 2-1/4 | ✓ | ✓ | | ✓ | ✓ | ✓ | ✓ |
| XRZ4 | 1 x 2-1/4 | ✓ | ✓ | | ✓ | ✓ | ✓ | ✓ |
| XRZ5 | 1-3/32 x 2-1/4 | ✓ | ✓ | | ✓ | ✓ | ✓ | ✓ |

Square Zamac Expanding Adapters

| | | | | | | | | |
|------|---------------|---|---|--|---|---|---|---|
| XSZ1 | 25/32 x 2-1/4 | ✓ | ✓ | | ✓ | ✓ | ✓ | ✓ |
|------|---------------|---|---|--|---|---|---|---|



CENTRAL LOCKING STEMS

| Suffix No. | Dimensions | MB | HP | HC | HS | MU |
|------------|----------------|----|----|----|----|----|
| CL01 | 27.8mm x 98mm* | ✓ | ✓ | ✓ | ✓ | ✓ |
| CL02 | 32mm x 54mm | ✓ | ✓ | ✓ | ✓ | ✓ |
| CL03 | 27.8mm x 98mm | ✓ | ✓ | ✓ | ✓ | ✓ |
| CL04 | 32mm x 54mm | ✓ | ✓ | ✓ | ✓ | ✓ |

*HP, HC, HS, MU are 27.8 mm x 96mm.



SWIVEL TOP PLATES

| Suffix No. | Dimensions | DW | CN | CH | CS | SS | NG | NS | PG | PA | RZ | GT | TM | DN |
|------------|-------------------|----|----|----|----|----|----|----|----|----|----|----|----|----|
| TP01 | 2-1/2" x 3-5/8" | ✓ | | ✓ | ✓ | ✓ | ✓ | ✓ | ✓ | ✓ | | | ✓ | ✓ |
| TP02 | 1-1/4" x 2-3/8" | | ✓ | | | | | | | | | | | |
| TP03 | 4" x 4-1/2" | | | | | | | | | | | | | |
| TP04 | 2.65" x 3" | | | ✓ | | ✓ | | | | | | | | |
| TP05 | 2.12" x 2.12" | | | | | | | | | | ✓ | | | |
| TP06 | 2.36" x 2.36" | | | | | | | | | | ✓ | | | |
| TP07 | 1-1/2" x 1-1/2" | | | | | | | | | | | ✓ | | |
| TP08 | 2-3/4" x 2-5/8" | | | | | | | | | | | ✓ | | |
| TP09 | 2-3/16" x 2-9/16" | | | | | | | | | | | ✓ | | |

Caster Series

| | |
|-----------|------------------------|
| CH | Chrome Hospital |
| CN | Chrome Neoteq |
| CS | Chrome Steel |
| DW | Dual wheel |
| DN | Neoteq Dual |
| GT | Grey Tech |
| HC | Hospital Bed Chrome |
| HP | Hospital Bed Plastic |
| HS | Hospital Bed Stainless |
| KS | Kick Stop |
| MB | Med-Bed Casters |
| MM | MediMaster |
| NM | Non-Magnetic |
| MU | Med-Ultra |
| NA | Nylon Antistatic |
| ND | Nylon Dark Gray |
| NG | Nylon Light Gray |
| NK | Nylon Black |
| NS | Nylon Plus Stainless |
| PA | Plastic Antistatic |
| PD | Plastic Dark Gray |
| PG | Plastic Light Gray |
| RZ | Razer |
| SS | Stainless Steel |
| ST | Solus Tech |
| TM | Twin-Med |
| TW | Twin Wheel |
| WC | Wheel Chair Casters |
| WO | Misc. Wheel Only |
| WW | Wheel Chair Wheels |

Continue next page

CASTER FITTINGS GUIDE

ROUND STEMS



| Suffix No. | Dimensions | CH | CS | NG | PG | PA | MB | HP | HC | HS |
|------------|---------------|----|----|----|----|----|----|----|----|----|
| RS01 | 22mm x 45mm | ✓ | ✓ | ✓ | ✓ | ✓ | | | | |
| RS02 | 25.4mm x 45mm | ✓ | ✓ | ✓ | ✓ | ✓ | | | | |
| RS03 | 27.8mm x 45mm | ✓ | ✓ | ✓ | ✓ | ✓ | ✓ | ✓ | ✓ | ✓ |
| RS04 | 20.5mm x 45mm | ✓ | ✓ | ✓ | ✓ | ✓ | | | | |
| RS05 | 32mm x 45mm | ✓ | ✓ | ✓ | ✓ | ✓ | ✓ | ✓ | ✓ | ✓ |

SQUARE STEMS



| Suffix No. | Dimensions | CH | CS | NG | PG | PA |
|------------|-----------------------|----|----|----|----|----|
| SQ01 | 3/4 x 2, no holes | ✓ | ✓ | ✓ | ✓ | ✓ |
| SQ02 | 1 x 1.75, 3 holes | ✓ | ✓ | ✓ | ✓ | ✓ |
| SQ03 | .850 x 2.2, grip ring | ✓ | ✓ | ✓ | ✓ | ✓ |

GRIP RING STEMS



| Suffix No. | Dimensions | TW | CN | CH | CS | NG | NS | PG | PA | RZ | GT | NM |
|------------|-------------------------------|----|----|----|----|----|----|----|----|----|----|----|
| GR01 | 7/16 x 7/8 round | ✓ | ✓ | | | | | | | ✓ | ✓ | ✓ |
| GR02 | 7/16 x 1-7/16 round | ✓ | | ✓ | ✓ | ✓ | | | | ✓ | ✓ | ✓ |
| GR03 | 3/8 x 7/8 round | | | | | | | | | | | |
| GR04 | 5/8 x 1-5/8 round | | | ✓ | ✓ | ✓ | | ✓ | ✓ | | | |
| GR05 | 3/4 x 1-5/8 round | | | ✓ | ✓ | ✓ | | ✓ | ✓ | | | |
| GR06 | 7/8 x 2 round | | | ✓ | | | | ✓ | ✓ | | | |
| GR07 | 1 x 1-7/8 round | | | ✓ | ✓ | ✓ | | ✓ | ✓ | | | |
| GR08 | 7/16 x 1-29/32 round | | | | | | | ✓ | ✓ | ✓ | ✓ | |
| GR09 | .845 x 2-3/16 round | | | ✓ | ✓ | ✓ | | ✓ | ✓ | | | |
| GR10 | 7/16 x 1-3/8 round | | | ✓ | ✓ | ✓ | | | | ✓ | | |
| GR11 | .845 x 2-3/16 round stainless | | | | | | ✓ | | | | | |
| GR12 | 7/16 x 1-15/16 round | | | | | ✓ | | | | | | |

THREADED STEMS



| Suffix No. | Dimensions | TW | CN | CH | CS | SS | NG | NS | PG | PA | ST | KS | MM | TM | WC | RZ | GT | NM |
|------------|----------------------------|----|----|----|----|----|----|----|----|----|----|----|----|----|----|----|----|----|
| TS01 | 1/2-13NC x 3/4 | | | ✓ | ✓ | | ✓ | | ✓ | ✓ | | | | | | | | |
| TS02 | 1/2-13NC x 1 | ✓ | | ✓ | ✓ | | ✓ | | ✓ | ✓ | | | | ✓ | | | | ✓ |
| TS03 | 1/2-13NC x 1-1/2 | ✓ | | ✓ | ✓ | | ✓ | | ✓ | ✓ | | | | ✓ | | | | ✓ |
| TS04 | 1/2-13NC x 2 | | | ✓ | ✓ | | ✓ | | ✓ | ✓ | | | | | | | | |
| TS05 | 7/16-14NC x 1-3/4 | | | ✓ | ✓ | | ✓ | | ✓ | ✓ | | | | | | | | |
| TS06 | 3/8-16NC x 1 | ✓ | ✓ | | | | | | | | | | | | | ✓ | ✓ | |
| TS07 | M12 x 1 | | | ✓ | ✓ | | ✓ | | ✓ | ✓ | | | | | | | | |
| TS11 | 1/2-13NC x 3/4 stainless | | | ✓ | ✓ | | ✓ | | ✓ | ✓ | | | | | | | | |
| TS12 | 1/2-13NC x 1 stainless | | | ✓ | ✓ | | ✓ | | ✓ | ✓ | | | | | | | | |
| TS13 | 1/2-13NC x 1-1/2 stainless | | | ✓ | ✓ | | ✓ | | ✓ | ✓ | | | | | | | | |
| TS14 | 1/2-13NC x 2 stainless | | | ✓ | ✓ | | ✓ | | ✓ | ✓ | | | | | | | | |
| TS15 | M10 X 19/32 | | | | | | | | | | ✓ | ✓ | | | | | ✓ | |
| TS16 | M12 X 25/32 | | | | | | | | | | ✓ | ✓ | | | | | | |
| TS17 | M14 x 7/8 | | | | | | | | | | ✓ | ✓ | | | | | | |
| TS18 | M16 x 25/32 | | | | | | | | | | ✓ | ✓ | | | | | | |
| TS19 | M12 x 1-1/8 | | | | | | | | | | ✓ | ✓ | | | | | | |
| TS20 | M10 x 43/64 | | | | | | | | ✓ | | | | | | | | | ✓ |
| TS21 | M12 x 60MM | | | ✓ | | | ✓ | | | | | | | | | | | |
| TS22 | 1/2-13 x 2-11/16 | | | ✓ | | | ✓ | | | | | | | | | | | |
| TS23 | M12 X 15MM | | | | | | | | | | | | ✓ | | | | | |
| TS24 | 3/8-16NC x 3/4" | | | | | | | | | | | | | | | | ✓ | ✓ |
| TS25 | 3/8-16NC x 1-1/2" | | | | | | | | | | | | | | | ✓ | ✓ | ✓ |

Caster Series

- CH** Chrome Hospital
- CN** Chrome Neoteq
- CS** Chrome Steel
- DW** Dual wheel
- DN** Neoteq Dual
- GT** Grey Tech
- HC** Hospital Bed Chrome
- HP** Hospital Bed Plastic
- HS** Hospital Bed Stainless
- KS** Kick Stop
- MB** Med-Bed Casters
- MM** MediMaster
- NM** Non-Magnetic
- MU** Med-Ultra
- NA** Nylon Antistatic
- ND** Nylon Dark Gray
- NG** Nylon Light Gray
- NK** Nylon Black
- NS** Nylon Plus Stainless
- PA** Plastic Antistatic
- PD** Plastic Dark Gray
- PG** Plastic Light Gray
- RZ** Razer
- SS** Stainless Steel
- ST** Solus Tech
- TM** Twin-Med
- TW** Twin Wheel
- WC** Wheel Chair Casters
- WO** Misc. Wheel Only
- WW** Wheel Chair Wheels

MEDCASTER MODEL NUMBERING SYSTEM

Below example is a Nylon Light Grey (NG) caster that has a 5" diameter QuickStart wheel with a dark grey tread, thread guard and Precision Ball bearing. The tread width is 1-1/4" wide. The fork type is swivel. The fitting type is threaded stem (1/2-13 x 1-1/2").

NG-05QDP-125-SW-TS03

| Caster Series | Wheel Diameter | Wheel Type | Bearing Type | Tread Width | Fork Type | Fitting Type | Fitting Code |
|----------------------------------|----------------|----------------------------------------------------------------|------------------------------|-----------------|---------------------------------|----------------------------|-----------------------------|
| CH Chrome Hospital | 01 1 | AM Anti-Microbial TPR | A Annular | 025 .25 | DL Directional Lock | GR Grip Ring | See page 3-4 for stem codes |
| CN Chrome Neoteq | 02 2 | AP Anti-static Polyurethane | B Ball | 050 .50 | DT Direction/Total Comb. | HK Hollow Kingpin | |
| CS Chrome Steel | 03 3 | AR Anti-static Rubber | D Delrin | 075 .75 | RB Rigid Brake | OS Octagon Stem | |
| DW Dual wheel | 35 3.5 | AT Anti-Static TPR | N Plain, Nylon | 100 1 | RG Rigid | RS Round Stem | |
| DN Neoteq Dual | 04 4 | HR High Temp Rubber | O Plain Bore | 125 1.25 | SB Side Brake | SP Special | |
| GT Grey Tech | 05 5 | CR Conductive Rubber | P Precision | 150 1.5 | SW Swivel | SQ Square Stem | |
| HC Hospital Bed Chrome | 06 6 | NR Neoprene Rubber | R Roller | 200 2 | TB Top Brake | CL System Stem | |
| HP Hospital Bed Plastic | 07 7 | NY Nylon | S Stainless Roller | | TL Total Lock | TP Top Plate | |
| HS Hospital Bed Stainless | 7.5 7.5 | PB Polyurethane Black | X Stainless Precision | | | TS Threaded Stem | |
| KS Kick Stop | 08 8 | PH Phenolic | | | | XR Expanding Round | |
| MB Med-Bed Casters | 24 24 | PP Polyolefin | | | | XS Expanding Square | |
| MM MediMaster | | PS Polyurethane Solid | | | | | |
| NM Non-Magnetic | | PY Polyurethane TPU | | | | | |
| MU Med-Ultra | | QB QuickStart (dark grey tread with black thread guard) | | | | | |
| NA Nylon Antistatic | | QD QuickStart (dark grey tread and thread guard) | | | | | |
| ND Nylon Dark Gray | | QL QuickStart (light grey tread and thread guard) | | | | | |
| NG Nylon Light Gray | | RM Rubber on Metal | | | | | |
| NK Nylon Black | | RP Rubber on Plastic | | | | | |
| NS Nylon Plus Stainless | | RR Rubber on Rubber | | | | | |
| PA Plastic Antistatic | | TP Thermoplastic Rubber | | | | | |
| PD Plastic Dark Gray | | | | | | | |
| PG Plastic Light Gray | | | | | | | |
| RZ Razer | | | | | | | |
| SS Stainless Steel | | | | | | | |
| ST Solus Tech | | | | | | | |
| TM Twin-Med | | | | | | | |
| TW Twin Wheel | | | | | | | |
| WC Wheel Chair Casters | | | | | | | |
| WO Misc. Wheel Only | | | | | | | |
| WW Wheel Chair Wheels | | | | | | | |

FORK/RIG NUMBERING SYSTEM

Fork/Rig models are similar to caster models except there is no wheel code. Below is an example of a fork/rig only model for a 5" diameter by 1-1/4" tread width wheel. The fork type is swivel. The fitting type is threaded stem (1/2-13 x 1-1/2").

NG-05-125-SW-TS03

WHEEL NUMBERING SYSTEM

Wheel replacement models are similar to caster models except the last 2 digits. Below example is a wheel for a Nylon Light Grey (NG) caster that has a 5" diameter QuickStart wheel with a dark grey tread, thread guard and Precision Ball Bearing. The tread width is 1-1/4" wide. The axle is 5/16".

NG-05QDP-125-05

| | |
|-----------|------------|
| 04 | 1/4" axle |
| 05 | 5/16" axle |
| 06 | 3/8" axle |
| 08 | 1/2" axle |
| 10 | 5/8" axle |
| 12 | 3/4" axle |

DUAL WHEEL (DW) CASTERS

TOP PLATE/
HOLLOW KINGPIN MODELS
FREE SWIVEL • TOTAL LOCK



APPLICATIONS

- Patient Lifts
- Medical Equipment
- Computer Equipment

FEATURES

- Low profile, easy swiveling and smooth rolling.
- Durable zinc plated finish
- Non-marking TPR rubber tread
- Foot activated total lock brake
- Integrated thread guards
- Dual ball bearing raceway
- Precision Bearings in Wheels

Our Dual wheel casters provide a low profile, easy swiveling and smooth rolling.

TOP PLATE SWIVEL MODELS

| Wheel Diameter (Inches) | Tread Width (Inches) | Wheel Description | Capacity (Lbs) | Load Height Inches (mm) | Swivel Radius Inches (mm) | Wheel Bearing | Model Number |
|-------------------------|----------------------|----------------------|----------------|-------------------------|---------------------------|---------------|----------------------|
| 3 | 2 | Thermoplastic Rubber | 220 | 4-1/16" (103) | 2-23/32 (69) | Precision | DW-03TPP-100-SW-TP01 |



TOP PLATE SWIVEL TOTAL LOCK MODELS (LOCKS WHEEL AND SWIVEL)

| Wheel Diameter (Inches) | Tread Width (Inches) | Wheel Description | Capacity (Lbs) | Load Height Inches (mm) | Swivel Radius Inches (mm) | Wheel Bearing | Model Number |
|-------------------------|----------------------|----------------------|----------------|-------------------------|---------------------------|---------------|----------------------|
| 3 | 2 | Thermoplastic Rubber | 220 | 4-1/16" (103) | 3-1/2 (89) | Precision | DW-03TPP-100-TL-TP01 |



HOLLOW KINGPIN MODELS

| Wheel Diameter (Inches) | Tread Width (Inches) | Wheel Description | Capacity (Lbs) | Load Height Inches (mm) | Swivel Radius Inches (mm) | Wheel Bearing | Model Number |
|-------------------------|----------------------|----------------------|----------------|-------------------------|---------------------------|---------------|----------------------|
| 3 | 2 | Thermoplastic Rubber | 220 | 3-15/16" (100) | 2-23/32 (69) | Precision | DW-03TPP-100-SW-HK01 |



HOLLOW KINGPIN TOTAL LOCK MODELS (LOCKS WHEEL AND SWIVEL)

| Wheel Diameter (Inches) | Tread Width (Inches) | Wheel Description | Capacity (Lbs) | Load Height Inches (mm) | Swivel Radius Inches (mm) | Wheel Bearing | Model Number |
|-------------------------|----------------------|----------------------|----------------|-------------------------|---------------------------|---------------|----------------------|
| 3 | 2 | Thermoplastic Rubber | 220 | 3-15/16" (100) | 3-1/2 (89) | Precision | DW-03TPP-100-TL-HK01 |



TOP PLATE FITTING TP01

Swivel Top Plate Pattern

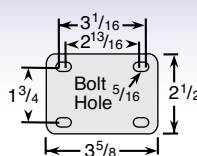

HOLLOW RIVET

Caster is provided assembled. Change HK01 code to HKU1 for unassembled. 1/2" I.D.

TWIN WHEEL (TW) CASTERS

GRIP RING & THREADED STEM MODELS
FREE SWIVEL • BRAKE



APPLICATIONS

- Medical Carts
- Furniture
- Concentrator Bases
- Utility Carts

FEATURES

- Durable Nylon Construction
- Riveted Axle
- Smooth Finish Design
- Custom colors available

Contemporary design features strong nylon construction.

GRIP RING/THREADED STEM MODELS

| Wheel Diameter (Inches) | Tread Width (Inches) | Wheel Description | Capacity (Lbs) | Load Height (Inches) | Swivel Radius (Inches) | Wheel Bearing | Model Number |
|-------------------------|----------------------|----------------------|----------------|----------------------|------------------------|---------------|------------------|
| 2 | 1-7/8 | Nylon Black | 90 | 2-29/64" (62) | 2" (51) | Plain | TW-02NYO-200-SW- |
| 3 | 2-1/4 | Thermoplastic Rubber | 165 | 3-1/4" (83) | 2-1/2" (64) | Plain | TW-03TPO-200-SW- |
| 3 | 2-1/4 | Nylon Black | 165 | 3-1/4" (83) | 2-1/2" (64) | Plain | TW-03NYO-200-SW- |
| 4 | 2-3/8 | Polyurethane Black | 175 | 4-3/8" (111) | 3-5/8" (92) | Plain | TW-04PBO-200-SW- |
| 4 | 2-3/8 | Nylon Black | 175 | 4-3/8" (111) | 3-5/8" (92) | Plain | TW-04NYO-200-SW- |
| 5 | 2-3/8 | Polyurethane Black | 180 | 5-7/16" (138) | 4-1/2" (114) | Plain | TW-05PBO-200-SW- |
| 5 | 2-3/8 | Nylon Black | 180 | 5-7/16" (138) | 4-1/2" (114) | Plain | TW-05NYO-200-SW- |



GRIP RING/THREADED STEM BRAKE MODELS

| Wheel Diameter (Inches) | Tread Width (Inches) | Wheel Description | Capacity (Lbs) | Load Height (Inches) | Swivel Radius (Inches) | Wheel Bearing | Model Number |
|-------------------------|----------------------|----------------------|----------------|----------------------|------------------------|---------------|------------------|
| 3 | 2-1/4 | Thermoplastic Rubber | 165 | 3-1/4" (83) | 2-1/2" (64) | Plain | TW-03TPO-200-TB- |
| 3 | 2-1/4 | Nylon Black | 165 | 3-1/4" (83) | 2-1/2" (64) | Plain | TW-03NYO-200-TB- |
| 4 | 2-3/8 | Polyurethane Black | 175 | 4-3/8" (111) | 3-5/8" (92) | Plain | TW-04PBO-200-TB- |
| 4 | 2-3/8 | Nylon Black | 175 | 4-3/8" (111) | 3-5/8" (92) | Plain | TW-04NYO-200-TB- |
| 5 | 2-3/8 | Polyurethane Black | 180 | 5-7/16" (138) | 4-1/2" (114) | Plain | TW-05PBO-200-TB- |
| 5 | 2-3/8 | Nylon Black | 180 | 5-7/16" (138) | 4-1/2" (114) | Plain | TW-05NYO-200-TB- |



Top Plate models are available in some of the above sizes, please consult factory.

Specify Grip Ring Stem (GR) or Threaded Stem (TS) code, see fittings below for dimensions:

GRIP RING STEM FITTINGS

See fittings page for more options.

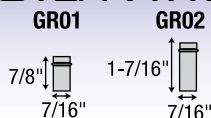

THREADED STEM FITTINGS

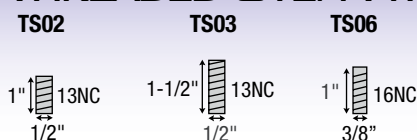

GREY TECH (GT) CASTERS

GRIP RING STEM, THREADED
STEM & SWIVEL PLATE MODELS
FREE SWIVEL • BRAKE



- APPLICATIONS**
- Electronic Equipment
 - Medical Equipment
 - Audio/Visual Equipment
 - Furniture

- FEATURES**
- Soft 70-75/A durometer tread constructed of high-tech thermoplastic elastomer
 - High load ratings
 - Quite mobility
 - Riveted axle for positive wheel retention

Soft tread twin wheel caster for quiet mobility

GRIP RING/THREADED STEM MODELS

| Wheel Diameter Inches (mm) | Tread Width (Inches) | Wheel Description | Capacity (Lbs) | Load Height Inches (mm) | Swivel Radius Inches (mm) | Wheel Bearing | Model Number |
|----------------------------|----------------------|----------------------|----------------|-------------------------|---------------------------|---------------|------------------|
| 2 (50) | 2-1/4 | Thermoplastic Rubber | 75 | 2-1/4" (57) | 1-13/16" (46) | Plain | GT-02TPO-200-SW- |
| 2-3/8 (60) | 2-1/4 | Thermoplastic Rubber | 100 | 2-5/8" (67) | 2-1/16" (52) | Plain | GT-23TPO-200-SW- |
| 3 (75) | 2-1/4 | Thermoplastic Rubber | 165 | 3-1/4" (83) | 2-1/2" (64) | Plain | GT-03TPO-200-SW- |
| 4 (100) | 2-1/4 | Thermoplastic Rubber | 225 | 4-3/8" (111) | 3-5/8" (92) | Plain | GT-04TPO-200-SW- |
| 5 (125) | 2-1/4 | Thermoplastic Rubber | 225 | 5-7/16" (138) | 4-1/2" (114) | Plain | GT-05TPO-200-SW- |

GRIP RING/THREADED STEM BRAKE MODELS

| | | | | | | | |
|------------|-------|----------------------|-----|---------------|--------------|-------|------------------|
| 2 (50) | 2-1/4 | Thermoplastic Rubber | 75 | 2-1/4" (57) | 2-3/8" (60) | Plain | GT-02TPO-200-TB- |
| 2-3/8 (60) | 2-1/4 | Thermoplastic Rubber | 100 | 2-5/8" (67) | 2-1/2" (63) | Plain | GT-23TPO-200-TB- |
| 3 (75) | 2-1/4 | Thermoplastic Rubber | 165 | 3-1/4" (83) | 3-3/16" (81) | Plain | GT-03TPO-200-TB- |
| 4 (100) | 2-1/4 | Thermoplastic Rubber | 225 | 4-3/8" (111) | 4-1/2" (114) | Plain | GT-04TPO-200-TB- |
| 5 (125) | 2-1/4 | Thermoplastic Rubber | 225 | 5-7/16" (138) | 5-1/8" (130) | Plain | GT-05TPO-200-TB- |

TOP PLATE MODELS

| | | | | | | | |
|------------|-------|----------------------|-----|--------------|---------------|-------|------------------|
| 2 (50) | 2-1/4 | Thermoplastic Rubber | 75 | 2-3/8" (60) | 1-13/16" (46) | Plain | GT-02TPO-200-SW- |
| 2-3/8 (60) | 2-1/4 | Thermoplastic Rubber | 100 | 2-3/4" (70) | 2-1/16" (52) | Plain | GT-23TPO-200-SW- |
| 3 (75) | 2-1/4 | Thermoplastic Rubber | 165 | 3-1/2" (89) | 2-1/2" (64) | Plain | GT-03TPO-200-SW- |
| 4 (100) | 2-1/4 | Thermoplastic Rubber | 225 | 4-5/8" (117) | 3-5/8" (92) | Plain | GT-04TPO-200-SW- |
| 5 (125) | 2-1/4 | Thermoplastic Rubber | 225 | 5-5/8" (143) | 4-1/2" (114) | Plain | GT-05TPO-200-SW- |

TOP PLATE BRAKE MODELS

| | | | | | | | |
|------------|-------|----------------------|-----|--------------|--------------|-------|------------------|
| 2 (50) | 2-1/4 | Thermoplastic Rubber | 75 | 2-3/8" (60) | 2-3/8" (60) | Plain | GT-02TPO-200-TB- |
| 2-3/8 (60) | 2-1/4 | Thermoplastic Rubber | 100 | 2-3/4" (70) | 2-1/2" (63) | Plain | GT-23TPO-200-TB- |
| 3 (75) | 2-1/4 | Thermoplastic Rubber | 165 | 3-1/2" (89) | 3-3/16" (81) | Plain | GT-03TPO-200-TB- |
| 4 (100) | 2-1/4 | Thermoplastic Rubber | 225 | 4-5/8" (117) | 4-1/2" (114) | Plain | GT-04TPO-200-TB- |
| 5 (125) | 2-1/4 | Thermoplastic Rubber | 225 | 5-5/8" (143) | 5-1/8" (130) | Plain | GT-05TPO-200-TB- |



Specify fitting code, see fittings below for dimensions:

GRIP RING STEM FITTINGS

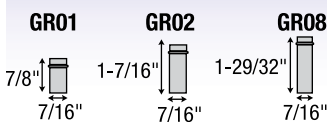

THREADED STEM FITTINGS



TOP PLATES

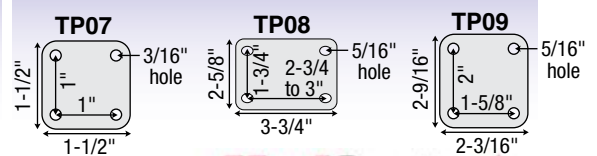

See fittings page for more options.

1-800-215-8220

MEDIMASTER (MM)

THREADED STEM MODELS

FREE SWIVEL • BRAKE



APPLICATIONS

- Nursing Home Beds
- Medical Carts
- Electronic Equipment
- Patient Aids

FEATURES

- Two Precision ball bearings located in the swivel raceway
- Wheels have precision ball bearings for easy rollability
- Our design protects axle/bearing areas from hair/water
- Wheels can be removed for easy cleaning

The MediMaster body and wheel cores are made of Nylon 6 material for added strength and durability. Our wheel treads are made of Thermoplastic polyurethane.



FREE SWIVEL MODELS

| Wheel Diameter (Inches) | Tread Width Inches (mm) | Wheel Description | Capacity (Lbs) | Load Height Inches (mm) | Swivel Lead Inches (mm) | Wheel Bearing | Model Number |
|-------------------------|-------------------------|-------------------|----------------|-------------------------|-------------------------|----------------|-----------------------|
| 4 | 2-13/16" (72) | Polyurethane Gray | 220 | 4-23/32" (120) | 3-5/16" (84) | Precision Ball | MM-04PYP-281-SW-_____ |



BRAKE MODELS

| Wheel Diameter (Inches) | Tread Width Inches (mm) | Wheel Description | Capacity (Lbs) | Load Height Inches (mm) | Swivel Lead Inches/mm | Wheel Bearing | Model Number |
|-------------------------|-------------------------|-------------------|----------------|-------------------------|-----------------------|----------------|-----------------------|
| 4 | 2-13/16" (72) | Polyurethane Gray | 220 | 4-23/32" (120) | 3-35/64" (90) | Precision Ball | MM-04PYP-281-TB-_____ |

THREADED STEM FITTINGS

See fittings page for more options.

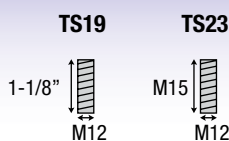

Specify Threaded Stem (TS) code, see fittings below for dimensions:



NON-MAGNETIC (NM)

THREADED STEM AND GRIP RING STEM MODELS

FREE SWIVEL

APPLICATIONS

- Medical Equipment
- Hospital Carts
- Electronic Equipment

FEATURES

- Non-magnetic caster is MRI safe
- RoHS compliant
- Soft 70-75/A durometer tread constructed of high-tech thermoplastic elastomer
- High load ratings
- Quiet mobility

Non-magnetic casters are designed for rooms that are subject to highly magnetic forces such as MRI and other scientific equipment.



GRIP RING/THREADED STEM MODELS

| Wheel Diameter Inches (mm) | Tread Width (Inches) | Wheel Description | Capacity (Lbs) | Load Height Inches (mm) | Swivel Radius Inches (mm) | | |
|----------------------------|----------------------|----------------------|----------------|-------------------------|---------------------------|-------|------------------|
| 2 (50) | 2-1/4 | Thermoplastic Rubber | 75 | 2-1/4" (57) | 1-13/16" (46) | Plain | NM-02TPO-200-SW- |
| 2-3/8 (60) | 2-1/4 | Thermoplastic Rubber | 100 | 2-1/2" (63) | 2-1/8" (54) | Plain | NM-23TPO-200-SW- |
| 3 (75) | 2-1/4 | Thermoplastic Rubber | 165 | 3-3/16" (81) | 2-1/2" (64) | Plain | NM-03TPO-200-SW- |



GRIP RING STEM FITTINGS

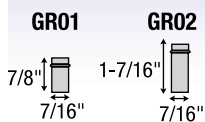

THREADED STEM FITTINGS

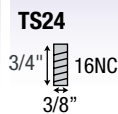

TWIN-MED (TM)

THREADED STEM MODELS

FREE SWIVEL • BRAKE

APPLICATIONS

- Nursing Home Beds
- Medical Carts
- Diagnostic Equipment
- Electronic Equipment
- Patient Aids
- Patient Lifts

FEATURES

- Double ball bearing located in the swivel raceway
- Wheels have easy rollability
- Our design protects axle/bearing areas from hair/water
- Total Lock models lock both the wheel and swivel
- Directional Lock (locks swivel) models are available on the 3" and 4" Models. Please consult factory.

Special colors available. Consult factory.



FREE SWIVEL MODELS

| Wheel Diameter (Inches) | Tread Width Inches (mm) | Wheel Description | Capacity (Lbs) | Load Height Inches (mm) | Swivel Lead Inches (mm) | Wheel Bearing | Model Number |
|-------------------------|-------------------------|-------------------|----------------|-------------------------|-------------------------|---------------|----------------------|
| 3 | 2-5/16" (59) | Polyurethane Gray | 165 | 3-3/4" (95) | 2-5/16" (59) | Plain | TM-03PYO-281-SW-____ |
| 4 | 2-39/64" (66) | Polyurethane Gray | 220 | 5" (127) | 3-1/8" (79) | Plain | TM-04PYO-281-SW-____ |
| 5 | 3" (76) | Polyurethane Gray | 246 | 6" (152) | 4" (102) | Precision | TM-05PYP-281-SW-____ |



TOTAL LOCK MODELS (LOCKS WHEEL AND SWIVEL)

| Wheel Diameter (Inches) | Tread Width Inches (mm) | Wheel Description | Capacity (Lbs) | Load Height Inches (mm) | Swivel Lead Inches (mm) | Wheel Bearing | Model Number |
|-------------------------|-------------------------|-------------------|----------------|-------------------------|-------------------------|---------------|----------------------|
| 3 | 2-5/16" (59) | Polyurethane Gray | 165 | 3-3/4" (95) | 2-5/16" (59) | Plain | TM-03PYO-281-TL-____ |
| 4 | 2-39/64" (66) | Polyurethane Gray | 220 | 5" (127) | 3-1/2" (89) | Plain | TM-04PYO-281-TL-____ |
| 5 | 3" (76) | Polyurethane Gray | 246 | 6" (152) | 4-11/64" (106) | Precision | TM-05PYP-281-TL-____ |

THREADED STEM FITTINGS

See fittings page for more options.

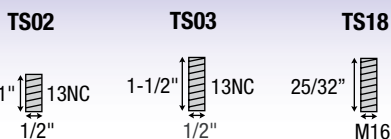

Specify Threaded Stem (TS) code, see fittings below for dimensions:



TWIN-MED (TM)

TOP PLATE MODELS
FREE SWIVEL • BRAKE



APPLICATIONS

- Nursing Home Beds
- Medical Carts
- Diagnostic Equipment
- Electronic Equipment
- Patient Aids
- Patient Lifts

FEATURES

- Double ball bearing located in the swivel raceway
- Wheels have easy rollability
- Our design protects axle/bearing areas from hair/water
- Total Lock models lock both the wheel and swivel
- Directional Lock (locks swivel) models are available on the 3" and 4" Models. Please consult factory.

Special colors available.
Consult factory.



FREE SWIVEL MODELS

| Wheel Diameter (Inches) | Tread Width Inches (mm) | Wheel Description | Capacity (Lbs) | Load Height Inches (mm) | Swivel Radius Inches (mm) | Wheel Bearing | Model Number |
|-------------------------|-------------------------|-------------------|----------------|-------------------------|---------------------------|---------------|----------------------|
| 3 | 2-5/16 (59) | Polyurethane Gray | 165 | 4-1/8" (105) | 2-5/16" (59) | Plain | TM-03PYO-281-SW-TP01 |
| 4 | 2-39/64" (66) | Polyurethane Gray | 220 | 5-3/8" (137) | 3-1/8" (79) | Plain | TM-04PYO-281-SW-TP01 |
| 5 | 3" (76) | Polyurethane Gray | 246 | 6-3/8" (162) | 4" (102) | Precision | TM-05PYP-281-SW-TP01 |



TOTAL LOCK MODELS (LOCKS WHEEL AND SWIVEL)

| Wheel Diameter (Inches) | Tread Width Inches (mm) | Wheel Description | Capacity (Lbs) | Load Height Inches (mm) | Swivel Lead Inches (mm) | Wheel Bearing | Model Number |
|-------------------------|-------------------------|-------------------|----------------|-------------------------|-------------------------|---------------|----------------------|
| 3 | 2-5/16 (59) | Polyurethane Gray | 165 | 4-1/8" (105) | 2-5/16" (59) | Plain | TM-03PYO-281-TL-TP01 |
| 4 | 2-39/64" (66) | Polyurethane Gray | 220 | 5-3/8" (137) | 3-1/2" (89) | Plain | TM-04PYO-281-TL-TP01 |
| 5 | 3" (76) | Polyurethane Gray | 246 | 6-3/8" (162) | 4-11/64" (106) | Precision | TM-05PYP-281-TL-TP01 |

TOP PLATE FITTINGS

See fittings page for more options.

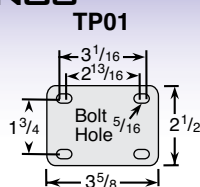

KICK STOP (KS)

FREE SWIVEL • TOTAL LOCK • DIRECTION LOCK



- APPLICATIONS**
- Medical and diagnostic equipment
 - Computer equipment
 - Electronic equipment
 - High-tech products

- FEATURES**
- Foot brake easily engaged; mechanically locks both swivel and wheel rotation
 - Strong pressure diecast metal construction for lasting performance and maximum reliability
 - Precision axle built to exacting tolerances for smooth operation and extended service life
 - Aluminum die cast body and wheel centers
 - Standard finish is white or ball burnished and lacquered

Medcaster Kick Stop casters give you the benefits of twin-wheel design with the convenience of a foot brake to lock both wheel and swivel simultaneously. This modern design features two wheels that spin independently of each other for easier turning in tight spots and for improved stability. Custom colors are available to match your equipment (Consult factory). Kick Stop casters are covered by world-wide patents and designs.

FREE SWIVEL MODELS

| Wheel Diameter (Inches) | Tread Width (Inches) | Wheel Description | Capacity (lbs) | Load Height Inches (mm) | Swivel Lead (Inches/mm) | Wheel Bearing | Model Number |
|-------------------------|----------------------|--------------------------|----------------|-------------------------|-------------------------|---------------|----------------------|
| 3 | 19/32 | Polyurethane Gray | 132 | 3-37/64" (91) | 7/8" (22) | Delrin | KS-03PYD-150-SW-____ |
| 3 | 19/32 | Polyurethane Black | 132 | 3-37/64" (91) | 7/8" (22) | Delrin | KS-03PBD-150-SW-____ |
| 4 | 19/32 | Anti-Static Black Rubber | 132 | 4-3/4" (120) | 1-9/64" (29) | Roller | KS-04ARR-150-SW-____ |
| 4 | 19/32 | Rubber Gray | 132 | 4-3/4" (120) | 1-9/64" (29) | Roller | KS-04RPR-150-SW-____ |
| 4 | 19/32 | Rubber Gray | 132 | 4-3/4" (120) | 1-9/64" (29) | Delrin | KS-04RPD-150-SW-____ |
| 5 | 5/8 | Anti-Static Black Rubber | 175 | 5-13/16" (148) | 1-35/64" (39) | Roller | KS-05ARR-150-SW-____ |
| 5 | 5/8 | Rubber Gray | 175 | 5-13/16" (148) | 1-35/64" (39) | Roller | KS-05RPR-150-SW-____ |
| 5 | 5/8 | Rubber Gray | 175 | 5-13/16" (148) | 1-35/64" (39) | Delrin | KS-05RPD-150-SW-____ |

TOTAL LOCK MODELS

| | | | | | | | |
|---|-------|--------------------------|-----|----------------|---------------|--------|----------------------|
| 3 | 19/32 | Polyurethane Gray | 132 | 3-37/64" (91) | 7/8" (22) | Delrin | KS-03PYD-150-TL-____ |
| 3 | 19/32 | Polyurethane Black | 132 | 3-37/64" (91) | 7/8" (22) | Delrin | KS-03PBD-150-TL-____ |
| 4 | 19/32 | Anti-Static Black Rubber | 132 | 4-3/4" (120) | 1-9/64" (29) | Roller | KS-04ARR-150-TL-____ |
| 4 | 19/32 | Rubber Gray | 132 | 4-3/4" (120) | 1-9/64" (29) | Roller | KS-04RPR-150-TL-____ |
| 4 | 19/32 | Rubber Gray | 132 | 4-3/4" (120) | 1-9/64" (29) | Delrin | KS-04RPD-150-TL-____ |
| 5 | 5/8 | Anti-Static Black Rubber | 175 | 5-13/16" (148) | 1-35/64" (39) | Roller | KS-05ARR-150-TL-____ |
| 5 | 5/8 | Rubber Gray | 175 | 5-13/16" (148) | 1-35/64" (39) | Roller | KS-05RPR-150-TL-____ |
| 5 | 5/8 | Rubber Gray | 175 | 5-13/16" (148) | 1-35/64" (39) | Delrin | KS-05RPD-150-TL-____ |

THREADED STEM FITTINGS

See fittings page for more options.

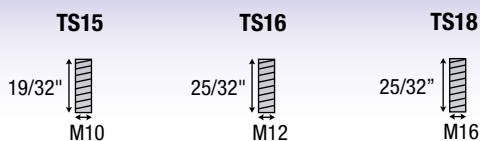

Specify Threaded Stem (TS) code, see fittings below for dimensions:



NEOTEQ DUAL (DN) COMFORT ROLL

TOP PLATE MODELS
FREE SWIVEL • BRAKE



APPLICATIONS

- Laboratory Equipment
- IV Stands
- Mobile Computer Stands
- Medical Equipment

FEATURES

- Bright Chrome Finish
- Dual wheels maneuver easily
- Matching Chrome Thread Guards for wheels
- Non-Marking Soft-Neoprene Rubber wheels
- Dual Ball Swivel Raceways for added strength
- Precision ball bearings in wheels for easier rollability
- Upper dustcap to prevent dirt and dust build-up

Dual Wheel Chrome NeoTeq series are designed to provide your equipment with a smooth and quiet roll with easy turning and maneuverability.

SWIVEL TOP PLATE MODELS



| Wheel Diameter (Inches) | Tread Width Inches (mjm) | Wheel Description | Capacity (Lbs) | Load Height Inches (mm) | Swivel Radius Inches (mm) | Wheel Bearing | Model Number |
|-------------------------|--------------------------|-------------------|----------------|-------------------------|---------------------------|----------------|----------------------|
| 2 | 1" (25) | Neoprene Rubber | 250 | 3-3/8" (86) | 2-3/8 (60) | Precision Ball | DN-02NRP-100-SW-TP01 |
| 2-1/2 | 1" (25) | Neoprene Rubber | 300 | 3-7/8 (98) | 2-1/2" (63) | Precision Ball | DN-25NRP-100-SW-TP01 |

Rigid models available.
Consult factory

FITTINGS TP01

See fittings page for more options.

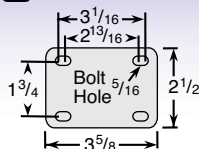

NEOTEQ (CN) COMFORT ROLL

SWIVEL/GRIP RING/THREADED/
HOLLOW KINGPIN

FREE SWIVEL • TOTAL LOCK



APPLICATIONS

- Laboratory Equipment
- IV Stands
- Mobile Computer Stands
- Medical Equipment

FEATURES

- Bright Chrome Finish
- Matching Chrome Thread Guards for wheels
- Non-Marking Soft-Neoprene Rubber wheels
- Dual Ball Swivel Raceways for added strength
- Total Lock Brake models lock both swivel and wheel
- Precision ball bearings in wheels for easier rollability
- Upper raceway seal to prevent dirt and dust build-up

Our Chrome NeoTeq series are designed to provide your equipment with a smooth and quiet roll.

SWIVEL TOP PLATE MODELS

| Wheel Diameter (Inches) | Tread Width (Inches) | Wheel Description | Capacity (Lbs) | Load Height Inches (mm) | Swivel Radius Inches (mm) | Wheel Bearing | Model Number |
|-------------------------|----------------------|-------------------|----------------|-------------------------|---------------------------|----------------|----------------------|
| 2 | 1 | Neoprene Rubber | 125 | 2-15/16" (75) | 2" (51) | Precision Ball | CN-02NRP-100-SW-TP02 |
| 3 | 1 | Neoprene Rubber | 175 | 4-5/32" (105) | 2-13/16" (71) | Precision Ball | CN-03NRP-100-SW-TP02 |



SWIVEL PLATE TOTAL LOCK MODELS

(LOCKS WHEEL AND SWIVEL)

| Wheel Diameter (Inches) | Tread Width (Inches) | Wheel Description | Capacity (Lbs) | Load Height Inches (mm) | Swivel Radius Inches (mm) | Wheel Bearing | Model Number |
|-------------------------|----------------------|-------------------|----------------|-------------------------|---------------------------|----------------|----------------------|
| 2 | 1 | Neoprene Rubber | 125 | 2-15/16" (75) | 2" (51) | Precision Ball | CN-02NRP-100-TL-TP02 |
| 3 | 1 | Neoprene Rubber | 175 | 4-5/32" (105) | 2-13/16" (71) | Precision Ball | CN-03NRP-100-TL-TP02 |



FITTINGS

Swivel Top Plate Fitting Pattern

2" diameter caster: 13/16" x 1-1/4" through 1-7/8" slotted

3" diameter caster: 13/16" x 1-7/8"

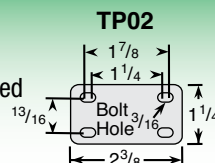

NEOTEQ (CN) COMFORT ROLL

GRIP RING STEM MODELS

| Wheel Diameter (Inches) | Tread Width (Inches) | Wheel Description | Capacity (Lbs) | Load Height Inches (mm) | Swivel Radius Inches (mm) | Wheel Bearing | Model Number |
|-------------------------|----------------------|-------------------|----------------|-------------------------|---------------------------|----------------|----------------------|
| 2 | 1 | Neoprene Rubber | 125 | 2-11/16" (68) | 2" (51) | Precision Ball | CN-02NRP-100-SW-GR01 |
| 3 | 1 | Neoprene Rubber | 175 | 4" (102) | 2-13/16" (71) | Precision Ball | CN-03NRP-100-SW-GR01 |



GRIP RING STEM TOTAL LOCK MODELS

(LOCKS WHEEL AND SWIVEL)

| | | | | | | | |
|---|---|-----------------|-----|---------------|---------------|----------------|----------------------|
| 2 | 1 | Neoprene Rubber | 125 | 2-11/16" (68) | 2" (51) | Precision Ball | CN-02NRP-100-TL-GR01 |
| 3 | 1 | Neoprene Rubber | 175 | 4" (102) | 2-13/16" (71) | Precision Ball | CN-03NRP-100-TL-GR01 |

THREADED STEM MODELS

| Wheel Diameter (Inches) | Tread Width (Inches) | Wheel Description | Capacity (Lbs) | Load Height Inches (mm) | Swivel Radius Inches (mm) | Wheel Bearing | Model Number |
|-------------------------|----------------------|-------------------|----------------|-------------------------|---------------------------|----------------|----------------------|
| 3 | 1 | Neoprene Rubber | 175 | 4" (102) | 2-13/16" (71) | Precision Ball | CN-03NRP-100-SW-TS06 |



THREADED STEM TOTAL LOCK MODELS

(LOCKS WHEEL AND SWIVEL)

| | | | | | | | |
|---|---|-----------------|-----|----------|---------------|----------------|----------------------|
| 3 | 1 | Neoprene Rubber | 175 | 4" (102) | 2-13/16" (71) | Precision Ball | CN-03NRP-100-TL-TS06 |
|---|---|-----------------|-----|----------|---------------|----------------|----------------------|

HOLLOW KINGPIN MODELS

| Wheel Diameter (Inches) | Tread Width (Inches) | Wheel Description | Capacity (Lbs) | Load Height Inches (mm) | Swivel Radius Inches (mm) | Wheel Bearing | Model Number |
|-------------------------|----------------------|-------------------|----------------|-------------------------|---------------------------|----------------|----------------------|
| 2 | 1 | Neoprene Rubber | 125 | 2-11/16" (68) | 2" (51) | Precision Ball | CN-02NRP-100-SW-HK04 |
| 3 | 1 | Neoprene Rubber | 175 | 4" (102) | 2-13/16" (71) | Precision Ball | CN-03NRP-100-SW-HK04 |

Recommended for use with 3/8" diameter fittings.



HOLLOW KINGPIN TOTAL LOCK MODELS

(LOCKS WHEEL AND SWIVEL)

| | | | | | | | |
|---|---|-----------------|-----|---------------|---------------|----------------|----------------------|
| 2 | 1 | Neoprene Rubber | 125 | 2-11/16" (68) | 2" (51) | Precision Ball | CN-02NRP-100-TL-HK04 |
| 3 | 1 | Neoprene Rubber | 175 | 4" (102) | 2-13/16" (71) | Precision Ball | CN-03NRP-100-TL-HK04 |

Recommended for use with 3/8" diameter fittings.

GRIP RING STEM

GR01



See fitting chart for additional options.

THREADED STEM

TS06



HOLLOW RIVET

Recommended for use with 3/8" diameter fittings.

RAZER (RZ)

TOP PLATE MODELS

FREE SWIVEL • TOTAL LOCK



APPLICATIONS

- Laundry Hampers
- Mobile Hospital Furniture
- Bassinets
- Hospital
- Chairs/Recliners
- Home Healthcare Beds

FEATURES

- Economical
- Polished zinc finish
- Double ball swivel raceways for added strength
- Total Lock Brake models lock both swivel and wheel
- Full thread guards for added protection (except 2" diameter models)
- Ball bearings included on 3" to 5" wheel diameter models. Plain bearing on 2" model

Polyurethane wheels also available, contact MedCaster.

SWIVEL TOP PLATE MODELS

| Wheel Diameter (Inches) | Tread Width (Inches) | Wheel Description | Capacity (Lbs) | Load Height Inches (mm) | Swivel Radius Inches (mm) | Wheel Bearing | Model Number |
|-------------------------|----------------------|-------------------|----------------|-------------------------|---------------------------|---------------|----------------------|
| 2 | 3/4" | Grey TPR | 110 | 2-13/16" (71) | 1.95" (50) | Plain | RZ-02TPN-070-SW-TP06 |
| 3 | 7/8" | Grey TPR | 140 | 4.07" (103) | 2.85" (73) | Ball | RZ-03TPP-090-SW-TP05 |
| 4 | 7/8" | Grey TPR | 160 | 4.92" (125) | 3.35" (85) | Ball | RZ-04TPP-090-SW-TP05 |
| 5 | 7/8" | Grey TPR | 165 | 6.04" (153) | 3.84" (98) | Ball | RZ-05TPP-090-SW-TP05 |



SWIVEL TOP PLATE TOTAL LOCK MODELS

(LOCKS WHEEL AND SWIVEL)

| Wheel Diameter (Inches) | Tread Width (Inches) | Wheel Description | Capacity (Lbs) | Load Height Inches (mm) | Swivel Radius Inches (mm) | Wheel Bearing | Model Number |
|-------------------------|----------------------|-------------------|----------------|-------------------------|---------------------------|---------------|----------------------|
| 2 | 3/4" | Grey TPR | 110 | 2-13/16" (71) | 3.23" (82) | Plain | RZ-02TPN-070-TL-TP06 |
| 3 | 7/8" | Grey TPR | 140 | 4.07" (103) | 3.90" (104) | Ball | RZ-03TPP-090-TL-TP05 |
| 4 | 7/8" | Grey TPR | 160 | 4.92" (125) | 4.19" (107) | Ball | RZ-04TPP-090-TL-TP05 |
| 5 | 7/8" | Grey TPR | 165 | 6.04" (153) | 4.19" (107) | Ball | RZ-05TPP-090-TL-TP05 |



TOP PLATE FITTING

Swivel Top Plate Pattern

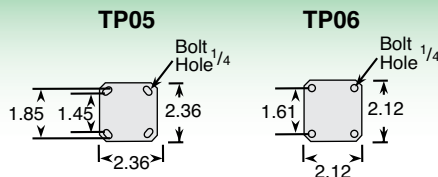

RAZER (RZ)

HOLLOW KINGPIN MODELS

FREE SWIVEL • TOTAL LOCK



APPLICATIONS

- Laundry Hampers
- Mobile Hospital Furniture
- Bassinets
- Hospital
- Chairs/ Recliners
- Home Healthcare Beds

FEATURES

- Economical
- Polished zinc finish
- Double ball swivel raceways for added strength
- Total Lock Brake models lock both swivel and wheel
- Full thread guards for added protection (except 2" diameter models)
- Ball bearings included on 3" to 5" wheel diameter models. Plain bearing on 2" model

Polyurethane wheels also available, contact MedCaster.

HOLLOW KINGPIN MODELS

| Wheel Diameter (Inches) | Tread Width (Inches) | Wheel Description | Capacity (Lbs) | Load Height Inches (mm) | Swivel Radius Inches (mm) | Wheel Bearing | Model Number |
|-------------------------|----------------------|-------------------|----------------|-------------------------|---------------------------|---------------|----------------------|
| 2 | 3/4" | Grey TPR | 110 | 2.75" (70) | 1.95" (50) | Plain | RZ-02TPN-070-SW-HK04 |
| 3 | 7/8" | Grey TPR | 140 | 3.98" (101) | 2.85" (73) | Ball | RZ-03TPP-090-SW-HK04 |
| 4 | 7/8" | Grey TPR | 160 | 4.84" (123) | 3.35" (85) | Ball | RZ-04TPP-090-SW-HK04 |
| 5 | 7/8" | Grey TPR | 165 | 5.95" (151) | 3.84" (98) | Ball | RZ-05TPP-090-SW-HK04 |



HOLLOW KINGPIN TOTAL LOCK MODELS

(LOCKS WHEEL AND SWIVEL)

| Wheel Diameter (Inches) | Tread Width (Inches) | Wheel Description | Capacity (Lbs) | Load Height Inches (mm) | Swivel Radius Inches (mm) | Wheel Bearing | Model Number |
|-------------------------|----------------------|-------------------|----------------|-------------------------|---------------------------|---------------|----------------------|
| 2 | 3/4" | Grey TPR | 110 | 2.75" (70) | 3.23" (82) | Plain | RZ-02TPN-070-TL-HK04 |
| 3 | 7/8" | Grey TPR | 140 | 3.98" (101) | 3.90" (104) | Ball | RZ-03TPP-090-TL-HK04 |
| 4 | 7/8" | Grey TPR | 160 | 4.84" (123) | 4.19" (107) | Ball | RZ-04TPP-090-TL-HK04 |
| 5 | 7/8" | Grey TPR | 165 | 5.95" (151) | 4.19" (107) | Ball | RZ-05TPP-090-TL-HK04 |



HOLLOW RIVET

Recommended for use with 3/8" diameter fittings.

RAZER (RZ)

GRIP RING STEM MODELS

FREE SWIVEL • TOTAL LOCK



APPLICATIONS

- Laundry Hampers
- Mobile Hospital Furniture
- Bassinets
- Hospital
- Chairs/ Recliners
- Home Healthcare Beds

FEATURES

- Economical
- Polished zinc finish
- Double ball swivel raceways for added strength
- Total Lock Brake models lock both swivel and wheel
- Full thread guards for added protection (except 2" diameter models)
- Ball bearings included on 3" to 5" wheel diameter models. Plain bearing on 2" model

Polyurethane wheels also available, contact MedCaster.

GRIP RING STEM MODELS

| Wheel Diameter (Inches) | Tread Width (Inches) | Wheel Description | Capacity (Lbs) | Load Height Inches (mm) | Swivel Radius Inches (mm) | Wheel Bearing | Model Number |
|-------------------------|----------------------|-------------------|----------------|-------------------------|---------------------------|---------------|-----------------------|
| 2 | 3/4" | Grey TPR | 110 | 2.75" (70) | 1.95" (50) | Plain | RZ-02TPN-070-SW-_____ |
| 3 | 7/8" | Grey TPR | 140 | 3.98" (101) | 2.85" (73) | Ball | RZ-03TPP-090-SW-_____ |
| 4 | 7/8" | Grey TPR | 160 | 4.84" (123) | 3.35" (85) | Ball | RZ-04TPP-090-SW-_____ |
| 5 | 7/8" | Grey TPR | 165 | 5.95" (151) | 3.84" (98) | Ball | RZ-05TPP-090-SW-_____ |



GRIP RING STEM TOTAL LOCK MODELS

(LOCKS WHEEL AND SWIVEL)

| Wheel Diameter (Inches) | Tread Width (Inches) | Wheel Description | Capacity (Lbs) | Load Height Inches (mm) | Swivel Radius Inches (mm) | Wheel Bearing | Model Number |
|-------------------------|----------------------|-------------------|----------------|-------------------------|---------------------------|---------------|-----------------------|
| 2 | 3/4" | Grey TPR | 110 | 2.75" (70) | 3.23" (82) | Plain | RZ-02TPN-070-TL-_____ |
| 3 | 7/8" | Grey TPR | 140 | 3.98" (101) | 3.90" (104) | Ball | RZ-03TPP-090-TL-_____ |
| 4 | 7/8" | Grey TPR | 160 | 4.84" (123) | 4.19" (107) | Ball | RZ-04TPP-090-TL-_____ |
| 5 | 7/8" | Grey TPR | 165 | 5.95" (151) | 4.19" (107) | Ball | RZ-05TPP-090-TL-_____ |



Specify Grip Ring Stem (GR) code, see fittings at left for dimensions.

GRIP RING STEM FITTINGS

See fittings page for more options.



RAZER (RZ)

THREADED STEM MODELS

FREE SWIVEL • TOTAL LOCK



APPLICATIONS

- Laundry Hampers
- Mobile Hospital Furniture
- Bassinets
- Hospital
- Chairs/ Recliners
- Home Healthcare Beds

FEATURES

- Economical
- Polished zinc finish
- Double ball swivel raceways for added strength
- Total Lock Brake models lock both swivel and wheel
- Full thread guards for added protection (except 2" diameter models)
- Ball bearings included on 3" to 5" wheel diameter models. Plain bearing on 2" model

Polyurethane wheels also available, contact MedCaster.

THREADED STEM MODELS

| Wheel Diameter (Inches) | Tread Width (Inches) | Wheel Description | Capacity (Lbs) | Load Height Inches (mm) | Swivel Radius Inches (mm) | Wheel Bearing | Model Number |
|-------------------------|----------------------|-------------------|----------------|-------------------------|---------------------------|---------------|-----------------------|
| 2 | 3/4" | Grey TPR | 110 | 2.75" (70) | 1.95" (50) | Plain | RZ-02TPN-070-SW-_____ |
| 3 | 7/8" | Grey TPR | 140 | 3.98" (101) | 2.85" (73) | Ball | RZ-03TPP-090-SW-_____ |
| 4 | 7/8" | Grey TPR | 160 | 4.84" (123) | 3.35" (85) | Ball | RZ-04TPP-090-SW-_____ |
| 5 | 7/8" | Grey TPR | 165 | 5.95" (151) | 3.84" (98) | Ball | RZ-05TPP-090-SW-_____ |



THREADED STEM TOTAL LOCK MODELS

(LOCKS WHEEL AND SWIVEL)

| Wheel Diameter (Inches) | Tread Width (Inches) | Wheel Description | Capacity (Lbs) | Load Height Inches (mm) | Swivel Radius Inches (mm) | Wheel Bearing | Model Number |
|-------------------------|----------------------|-------------------|----------------|-------------------------|---------------------------|---------------|-----------------------|
| 2 | 3/4" | Grey TPR | 110 | 2.75" (70) | 3.23" (82) | Plain | RZ-02TPN-070-TL-_____ |
| 3 | 7/8" | Grey TPR | 140 | 3.98" (101) | 3.90" (104) | Ball | RZ-03TPP-090-TL-_____ |
| 4 | 7/8" | Grey TPR | 160 | 4.84" (123) | 4.19" (107) | Ball | RZ-04TPP-090-TL-_____ |
| 5 | 7/8" | Grey TPR | 165 | 5.95" (151) | 4.19" (107) | Ball | RZ-05TPP-090-TL-_____ |



Specify Threaded Stem (TS) code, see fittings at left for dimensions:

THREADED STEM FITTINGS

See fittings page for more options.

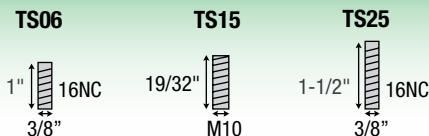

CHROME HOSPITAL (CH)

TOP PLATE MODELS

FREE SWIVEL • TOTAL LOCK • DIRECTION LOCK



- APPLICATIONS**
- Food Service
 - Case Carts
 - Utility Carts
 - Hospital Equipment
 - Institutional Equipment
 - Store Fixtures
 - Medical equipment

New larger brake pedal for easy braking action

- FEATURES**
- Chrome Plated Finish
 - Dual Ball Swivel Raceways for added strength
 - Total Lock Brake models lock both swivel and wheel
 - Directional lock models lock swivel only (helps with steering)
 - Precision ball bearings in wheels for easier rollability
 - Wheels have full thread guards for added protection

The CH series brings you Chrome Hospital casters at an affordable price.

SWIVEL TOP PLATE MODELS

| Wheel Diameter (Inches) | Tread Width (Inches) | Wheel Description | Capacity (Lbs) | Load Height Inches (mm) | Swivel Radius Inches (mm) | Wheel Bearing | Model Number |
|-------------------------|----------------------|----------------------|----------------|-------------------------|---------------------------|----------------|---------------------|
| 3 | 1-1/4 | Conductive Rubber | 165 | 4-7/16" (113) | 2-29/32" (74) | Annular Ball | CH-03CRB-125-SW-___ |
| 3 | 1-1/4 | Thermoplastic Rubber | 165 | 4-7/16" (113) | 2-29/32" (74) | Precision Ball | CH-03TPP-125-SW-___ |
| 3 | 1-1/4 | Anti-Microbial TPR | 165 | 4-7/16" (113) | 2-29/32" (74) | Precision Ball | CH-03AMP-125-SW-___ |
| 3 | 1-1/4 | Polyurethane TPU | 165 | 4-7/16" (113) | 2-29/32" (74) | Precision Ball | CH-03PYP-125-SW-___ |
| 4 | 1-1/4 | Conductive Rubber | 190 | 5-7/16" (138) | 3-37/64" (91) | Annular Ball | CH-04CRB-125-SW-___ |
| 4 | 1-1/4 | Thermoplastic Rubber | 190 | 5-7/16" (138) | 3-37/64" (91) | Precision Ball | CH-04TPP-125-SW-___ |
| 4 | 1-1/4 | Anti-Microbial TPR | 190 | 5-7/16" (138) | 3-37/64" (91) | Precision Ball | CH-04AMP-125-SW-___ |
| 4 | 1-1/4 | Polyurethane TPU | 190 | 5-7/16" (138) | 3-37/64" (91) | Precision Ball | CH-04PYP-125-SW-___ |
| 5 | 1-1/4 | Conductive Rubber | 220 | 6-7/16" (163) | 4-7/32" (108) | Annular Ball | CH-05CRB-125-SW-___ |
| 5 | 1-1/4 | Thermoplastic Rubber | 220 | 6-7/16" (163) | 4-7/32" (108) | Precision Ball | CH-05TPP-125-SW-___ |
| 5 | 1-1/4 | Anti-Microbial TPR | 220 | 6-7/16" (163) | 4-7/32" (108) | Precision Ball | CH-05AMP-125-SW-___ |
| 5 | 1-1/4 | Polyurethane TPU | 220 | 6-7/16" (163) | 4-7/32" (108) | Precision Ball | CH-05PYP-125-SW-___ |
| 6 | 1-1/4 | Conductive Rubber | 240 | 7-13/32" (188) | 4-39/64 (117) | Annular Ball | CH-06CRB-125-SW-___ |
| 6 | 1-1/4 | Thermoplastic Rubber | 240 | 7-13/32" (188) | 4-39/64 (117) | Precision Ball | CH-06TPP-125-SW-___ |
| 6 | 1-1/4 | Anti-Microbial TPR | 240 | 7-13/32" (188) | 4-39/64 (117) | Precision Ball | CH-06AMP-125-SW-___ |
| 6 | 1-1/4 | Polyurethane TPU | 240 | 7-13/32" (188) | 4-39/64 (117) | Precision Ball | CH-06PYP-125-SW-___ |



Anti-Microbial wheels have light green tread.



Rigid Models available change "SW to "RG"

Specify Top Plate (TP) code, see fittings at left for dimensions.

TOP PLATE FITTING

Swivel Top Plate Pattern

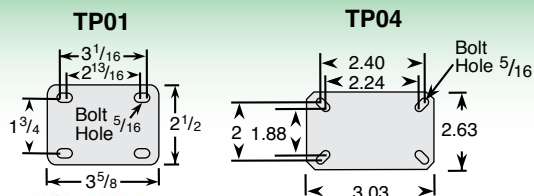

CHROME HOSPITAL (CH)

SWIVEL TOP PLATE TOTAL LOCK MODELS (LOCKS WHEEL AND SWIVEL)

| Wheel Diameter (Inches) | Tread Width (Inches) | Wheel Description | Capacity (Lbs) | Load Height Inches (mm) | Swivel Radius Inches (mm) | Wheel Bearing | Model Number |
|-------------------------|----------------------|----------------------|----------------|-------------------------|---------------------------|----------------|--------------------|
| 3 | 1-1/4 | Conductive Rubber | 165 | 4-7/16" (113) | 4-1/4" (108) | Annular Ball | CH-03CRB-125-TL-__ |
| 3 | 1-1/4 | Thermoplastic Rubber | 165 | 4-7/16" (113) | 4-1/4" (108) | Precision Ball | CH-03TPP-125-TL-__ |
| 3 | 1-1/4 | Anti-Microbial TPR | 165 | 4-7/16" (113) | 4-1/4" (108) | Precision Ball | CH-03AMP-125-TL-__ |
| 3 | 1-1/4 | Polyurethane TPU | 165 | 4-7/16" (113) | 4-1/4" (108) | Precision Ball | CH-03PYP-125-TL-__ |
| 4 | 1-1/4 | Conductive Rubber | 190 | 5-7/16" (138) | 4-35/64" (115) | Annular Ball | CH-04CRB-125-TL-__ |
| 4 | 1-1/4 | Thermoplastic Rubber | 190 | 5-7/16" (138) | 4-35/64" (115) | Precision Ball | CH-04TPP-125-TL-__ |
| 4 | 1-1/4 | Anti-Microbial TPR | 190 | 5-7/16" (138) | 4-35/64" (115) | Precision Ball | CH-04AMP-125-TL-__ |
| 4 | 1-1/4 | Polyurethane TPU | 190 | 5-7/16" (138) | 4-35/64" (115) | Precision Ball | CH-04PYP-125-TL-__ |
| 5 | 1-1/4 | Conductive Rubber | 220 | 6-7/16" (163) | 4-55/64" (123) | Annular Ball | CH-05CRB-125-TL-__ |
| 5 | 1-1/4 | Thermoplastic Rubber | 220 | 6-7/16" (163) | 4-55/64" (123) | Precision Ball | CH-05TPP-125-TL-__ |
| 5 | 1-1/4 | Anti-Microbial TPR | 220 | 6-7/16" (163) | 4-55/64" (123) | Precision Ball | CH-05AMP-125-TL-__ |
| 5 | 1-1/4 | Polyurethane TPU | 220 | 6-7/16" (163) | 4-55/64" (123) | Precision Ball | CH-05PYP-125-TL-__ |
| 6 | 1-1/4 | Conductive Rubber | 240 | 7-13/32" (188) | 4-55/64" (123) | Annular Ball | CH-06CRB-125-TL-__ |
| 6 | 1-1/4 | Thermoplastic Rubber | 240 | 7-13/32" (188) | 4-55/64" (123) | Precision Ball | CH-06TPP-125-TL-__ |
| 6 | 1-1/4 | Anti-Microbial TPR | 240 | 7-13/32" (188) | 4-55/64" (123) | Precision Ball | CH-06AMP-125-TL-__ |
| 6 | 1-1/4 | Polyurethane TPU | 240 | 7-13/32" (188) | 4-55/64" (123) | Precision Ball | CH-06PYP-125-TL-__ |



Total Lock
Change "SW" to "TL". **Red** sticker on pedal.

SWIVEL TOP PLATE DIRECTION LOCK MODELS (LOCKS SWIVEL ONLY)

| Wheel Diameter (Inches) | Tread Width (Inches) | Wheel Description | Capacity (Lbs) | Load Height Inches (mm) | Swivel Radius Inches (mm) | Wheel Bearing | Model Number |
|-------------------------|----------------------|----------------------|----------------|-------------------------|---------------------------|----------------|--------------------|
| 3 | 1-1/4 | Conductive Rubber | 165 | 4-7/16" (113) | 4-1/4" (108) | Annular Ball | CH-03CRB-125-DL-__ |
| 3 | 1-1/4 | Thermoplastic Rubber | 165 | 4-7/16" (113) | 4-1/4" (108) | Precision Ball | CH-03TPP-125-DL-__ |
| 3 | 1-1/4 | Anti-Microbial TPR | 165 | 4-7/16" (113) | 4-1/4" (108) | Precision Ball | CH-03AMP-125-DL-__ |
| 3 | 1-1/4 | Polyurethane TPU | 165 | 4-7/16" (113) | 4-1/4" (108) | Precision Ball | CH-03PYP-125-DL-__ |
| 4 | 1-1/4 | Conductive Rubber | 190 | 5-7/16" (138) | 4-35/64" (115) | Annular Ball | CH-04CRB-125-DL-__ |
| 4 | 1-1/4 | Thermoplastic Rubber | 190 | 5-7/16" (138) | 4-35/64" (115) | Precision Ball | CH-04TPP-125-DL-__ |
| 4 | 1-1/4 | Anti-Microbial TPR | 190 | 5-7/16" (138) | 4-35/64" (115) | Precision Ball | CH-04AMP-125-DL-__ |
| 4 | 1-1/4 | Polyurethane TPU | 190 | 5-7/16" (138) | 4-35/64" (115) | Precision Ball | CH-04PYP-125-DL-__ |
| 5 | 1-1/4 | Conductive Rubber | 220 | 6-7/16" (163) | 4-55/64" (123) | Annular Ball | CH-05CRB-125-DL-__ |
| 5 | 1-1/4 | Thermoplastic Rubber | 220 | 6-7/16" (163) | 4-55/64" (123) | Precision Ball | CH-05TPP-125-DL-__ |
| 5 | 1-1/4 | Anti-Microbial TPR | 220 | 6-7/16" (163) | 4-55/64" (123) | Precision Ball | CH-05AMP-125-DL-__ |
| 5 | 1-1/4 | Polyurethane TPU | 220 | 6-7/16" (163) | 4-55/64" (123) | Precision Ball | CH-05PYP-125-DL-__ |
| 6 | 1-1/4 | Conductive Rubber | 240 | 7-13/32" (188) | 4-55/64" (123) | Annular Ball | CH-06CRB-125-DL-__ |
| 6 | 1-1/4 | Thermoplastic Rubber | 240 | 7-13/32" (188) | 4-55/64" (123) | Precision Ball | CH-06TPP-125-DL-__ |
| 6 | 1-1/4 | Anti-Microbial TPR | 240 | 7-13/32" (188) | 4-55/64" (123) | Precision Ball | CH-06AMP-125-DL-__ |
| 6 | 1-1/4 | Polyurethane TPU | 240 | 7-13/32" (188) | 4-55/64" (123) | Precision Ball | CH-06PYP-125-DL-__ |



Direction Lock
Change "SW" to "DL". **Green** sticker on pedal.

TOP PLATE FITTING

Swivel Top Plate Pattern

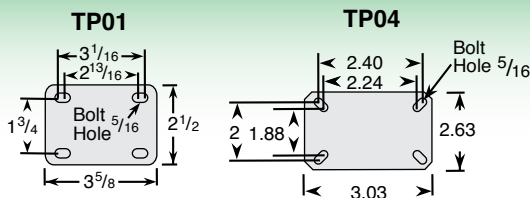

Specify Top Plate (TP) code, see fittings at left for dimensions.

CHROME HOSPITAL (CH)

HOLLOW KINGPIN MODELS

FREE SWIVEL • TOTAL LOCK • DIRECTION LOCK



APPLICATIONS

- Food Service
- Case Carts
- Utility Carts
- Hospital Equipment
- Institutional Equipment
- Store Fixtures
- Medical equipment

New larger brake pedal for easy braking action

FEATURES

- Chrome Plated Finish
- Dual Ball Swivel Raceways for added strength
- Total Lock Brake models lock both swivel and wheel
- Directional lock models lock swivel only (helps with steering)
- Precision ball bearings in wheels for easier rollability
- Wheels have full thread guards for added protection

The CH series brings you Chrome Hospital casters at an affordable price.

HOLLOW KINGPIN MODELS

| Wheel Diameter (Inches) | Tread Width (Inches) | Wheel Description | Capacity (lbs) | Load Height Inches (mm) | Swivel Radius Inches (mm) | Wheel Bearing | Model Number |
|-------------------------|----------------------|----------------------|----------------|-------------------------|---------------------------|----------------|----------------------|
| 3 | 1-1/4 | Conductive Rubber | 165 | 4-5/16" (109) | 2-29/32" (74) | Annular Ball | CH-03CRB-125-SW-HKU1 |
| 3 | 1-1/4 | Thermoplastic Rubber | 165 | 4-5/16" (109) | 2-29/32" (74) | Precision Ball | CH-03TPP-125-SW-HKU1 |
| 3 | 1-1/4 | Anti-Microbial TPR | 165 | 4-5/16" (109) | 2-29/32" (74) | Precision Ball | CH-03AMP-125-SW-HKU1 |
| 3 | 1-1/4 | Polyurethane TPU | 165 | 4-5/16" (109) | 2-29/32" (74) | Precision Ball | CH-03PYP-125-SW-HKU1 |
| 4 | 1-1/4 | Conductive Rubber | 165 | 5-5/16" (135) | 3-37/64" (91) | Annular Ball | CH-04CRB-125-SW-HKU1 |
| 4 | 1-1/4 | Thermoplastic Rubber | 190 | 5-5/16" (135) | 3-37/64" (91) | Precision Ball | CH-04TPP-125-SW-HKU1 |
| 4 | 1-1/4 | Anti-Microbial TPR | 190 | 5-5/16" (135) | 3-37/64" (91) | Precision Ball | CH-04AMP-125-SW-HKU1 |
| 4 | 1-1/4 | Polyurethane TPU | 190 | 5-5/16" (135) | 3-37/64" (91) | Precision Ball | CH-04PYP-125-SW-HKU1 |
| 5 | 1-1/4 | Conductive Rubber | 220 | 6-5/16" (160) | 4-7/32" (108) | Annular Ball | CH-05CRB-125-SW-HKU1 |
| 5 | 1-1/4 | Thermoplastic Rubber | 220 | 6-5/16" (160) | 4-7/32" (108) | Precision Ball | CH-05TPP-125-SW-HKU1 |
| 5 | 1-1/4 | Anti-Microbial TPR | 220 | 6-5/16" (160) | 4-7/32" (108) | Precision Ball | CH-05AMP-125-SW-HKU1 |
| 5 | 1-1/4 | Polyurethane TPU | 220 | 6-5/16" (160) | 4-7/32" (108) | Precision Ball | CH-05PYP-125-SW-HKU1 |
| 6 | 1-1/4 | Conductive Rubber | 240 | 7-9/32" (185) | 4-39/64 (117) | Annular Ball | CH-06CRB-125-SW-HKU1 |
| 6 | 1-1/4 | Thermoplastic Rubber | 240 | 7-9/32" (185) | 4-39/64 (117) | Precision Ball | CH-06TPP-125-SW-HKU1 |
| 6 | 1-1/4 | Anti-Microbial TPR | 240 | 7-9/32" (185) | 4-39/64 (117) | Precision Ball | CH-06AMP-125-SW-HKU1 |
| 6 | 1-1/4 | Polyurethane TPU | 240 | 7-9/32" (185) | 4-39/64 (117) | Precision Ball | CH-06PYP-125-SW-HKU1 |



Anti-Microbial wheels have light green tread.



HOLLOW KINGPIN

Caster is provided unassembled to make it easy to add your choice of fitting. If you would like these assembled change HKU1 to HKO1. 1/2 I.D.

HOLLOW KINGPIN

Caster is provided unassembled to make it easy to add your choice of fitting. If you would like these assembled change HKU1 to HKO1. 1/2 I.D.



CHROME HOSPITAL (CH)

HOLLOW KINGPIN MODELS

FREE SWIVEL • TOTAL LOCK • DIRECTION LOCK

| Wheel Diameter (Inches) | Tread Width (Inches) | Wheel Description | Capacity (Lbs) | Load Height Inches (mm) | Swivel Radius Inches (mm) | Wheel Bearing | Model Number |
|-------------------------|----------------------|----------------------|----------------|-------------------------|---------------------------|----------------|----------------------|
| 3 | 1-1/4 | Conductive Rubber | 165 | 4-5/16" (109) | 4-1/4" (108) | Precision Ball | CH-03CRB-125-TL-HKU1 |
| 3 | 1-1/4 | Thermoplastic Rubber | 165 | 4-5/16" (109) | 4-1/4" (108) | Precision Ball | CH-03TPP-125-TL-HKU1 |
| 3 | 1-1/4 | Anti-Microbial TPR | 165 | 4-5/16" (109) | 4-1/4" (108) | Precision Ball | CH-03AMP-125-TL-HKU1 |
| 3 | 1-1/4 | Polyurethane TPU | 165 | 4-5/16" (109) | 4-1/4" (108) | Precision Ball | CH-03PYP-125-TL-HKU1 |
| 4 | 1-1/4 | Conductive Rubber | 190 | 5-5/16" (135) | 4-35/64" (115) | Precision Ball | CH-04CRB-125-TL-HKU1 |
| 4 | 1-1/4 | Thermoplastic Rubber | 190 | 5-5/16" (135) | 4-35/64" (115) | Precision Ball | CH-04TPP-125-TL-HKU1 |
| 4 | 1-1/4 | Anti-Microbial TPR | 190 | 5-5/16" (135) | 4-35/64" (115) | Precision Ball | CH-04AMP-125-TL-HKU1 |
| 4 | 1-1/4 | Polyurethane TPU | 190 | 5-5/16" (135) | 4-35/64" (115) | Precision Ball | CH-04PYP-125-TL-HKU1 |
| 5 | 1-1/4 | Conductive Rubber | 220 | 6-5/16" (160) | 4-55/64" (123) | Precision Ball | CH-05CRB-125-TL-HKU1 |
| 5 | 1-1/4 | Thermoplastic Rubber | 220 | 6-5/16" (160) | 4-55/64" (123) | Precision Ball | CH-05TPP-125-TL-HKU1 |
| 5 | 1-1/4 | Anti-Microbial TPR | 220 | 6-5/16" (160) | 4-55/64" (123) | Precision Ball | CH-05AMP-125-TL-HKU1 |
| 5 | 1-1/4 | Polyurethane TPU | 220 | 6-5/16" (160) | 4-55/64" (123) | Precision Ball | CH-05PYP-125-TL-HKU1 |
| 6 | 1-1/4 | Conductive Rubber | 240 | 7-9/32" (185) | 4-55/64" (123) | Precision Ball | CH-06CRB-125-TL-HKU1 |
| 6 | 1-1/4 | Thermoplastic Rubber | 240 | 7-9/32" (185) | 4-55/64" (123) | Precision Ball | CH-06TPP-125-TL-HKU1 |
| 6 | 1-1/4 | Anti-Microbial TPR | 240 | 7-9/32" (185) | 4-55/64" (123) | Precision Ball | CH-06AMP-125-TL-HKU1 |
| 6 | 1-1/4 | Polyurethane TPU | 240 | 7-9/32" (185) | 4-55/64" (123) | Precision Ball | CH-06PYP-125-TL-HKU1 |



Total Lock
Change "SW"
to "TL". **Red**
sticker on pedal.

HOLLOW KINGPIN DIRECTION LOCK MODELS

(LOCKS SWIVEL ONLY)

| Wheel Diameter (Inches) | Tread Width (Inches) | Wheel Description | Capacity (Lbs) | Load Height Inches (mm) | Swivel Radius Inches (mm) | Wheel Bearing | Model Number |
|-------------------------|----------------------|----------------------|----------------|-------------------------|---------------------------|----------------|----------------------|
| 3 | 1-1/4 | Conductive Rubber | 165 | 4-5/16" (109) | 4-1/4" (108) | Precision Ball | CH-03CRB-125-DL-HKU1 |
| 3 | 1-1/4 | Thermoplastic Rubber | 165 | 4-5/16" (109) | 4-1/4" (108) | Precision Ball | CH-03TPP-125-DL-HKU1 |
| 3 | 1-1/4 | Anti-Microbial TPR | 165 | 4-5/16" (109) | 4-1/4" (108) | Precision Ball | CH-03AMP-125-DL-HKU1 |
| 3 | 1-1/4 | Polyurethane TPU | 165 | 4-5/16" (109) | 4-1/4" (108) | Precision Ball | CH-03PYP-125-DL-HKU1 |
| 4 | 1-1/4 | Conductive Rubber | 190 | 5-5/16" (135) | 4-35/64" (115) | Precision Ball | CH-04CRB-125-DL-HKU1 |
| 4 | 1-1/4 | Thermoplastic Rubber | 190 | 5-5/16" (135) | 4-35/64" (115) | Precision Ball | CH-04TPP-125-DL-HKU1 |
| 4 | 1-1/4 | Anti-Microbial TPR | 190 | 5-5/16" (135) | 4-35/64" (115) | Precision Ball | CH-04AMP-125-DL-HKU1 |
| 4 | 1-1/4 | Polyurethane TPU | 190 | 5-5/16" (135) | 4-35/64" (115) | Precision Ball | CH-04PYP-125-DL-HKU1 |
| 5 | 1-1/4 | Conductive Rubber | 220 | 6-5/16" (160) | 4-55/64" (123) | Precision Ball | CH-05CRB-125-DL-HKU1 |
| 5 | 1-1/4 | Thermoplastic Rubber | 220 | 6-5/16" (160) | 4-55/64" (123) | Precision Ball | CH-05TPP-125-DL-HKU1 |
| 5 | 1-1/4 | Anti-Microbial TPR | 220 | 6-5/16" (160) | 4-55/64" (123) | Precision Ball | CH-05AMP-125-DL-HKU1 |
| 5 | 1-1/4 | Polyurethane TPU | 220 | 6-5/16" (160) | 4-55/64" (123) | Precision Ball | CH-05PYP-125-DL-HKU1 |
| 6 | 1-1/4 | Conductive Rubber | 240 | 7-9/32" (185) | 4-55/64" (123) | Precision Ball | CH-06CRB-125-DL-HKU1 |
| 6 | 1-1/4 | Thermoplastic Rubber | 240 | 7-9/32" (185) | 4-55/64" (123) | Precision Ball | CH-06TPP-125-DL-HKU1 |
| 6 | 1-1/4 | Anti-Microbial TPR | 240 | 7-9/32" (185) | 4-55/64" (123) | Precision Ball | CH-06AMP-125-DL-HKU1 |
| 6 | 1-1/4 | Polyurethane TPU | 240 | 7-9/32" (185) | 4-55/64" (123) | Precision Ball | CH-06PYP-125-DL-HKU1 |



Direction Lock
Change "SW"
to "DL". **Green**
sticker on pedal.

HOLLOW KINGPIN

Caster is provided unassembled to make it easy to add your choice of fitting. If you would like these assembled change HKU1 to HKO1. 1/2 I.D.



CHROME HOSPITAL (CH)

GRIP RING STEM MODELS

FREE SWIVEL • TOTAL LOCK • DIRECTION LOCK



APPLICATIONS

- Food Service
- Case Carts
- Utility Carts
- Hospital Equipment
- Institutional Equipment
- Store Fixtures
- Medical equipment

New larger brake pedal for easy braking action

FEATURES

- Chrome Plated Finish
- Dual Ball Swivel Raceways for added strength
- Total Lock Brake models lock both swivel and wheel
- Directional lock models lock swivel only (helps with steering)
- Precision ball bearings in wheels for easier rollability
- Wheels have full thread guards for added protection

The CH series brings you Chrome Hospital casters at an affordable price.

GRIP RING STEM MODELS

| Wheel Diameter (Inches) | Tread Width (Inches) | Wheel Description | Capacity (lbs) | Load Height Inches (mm) | Swivel Radius Inches (mm) | Wheel Bearing | Model Number |
|-------------------------|----------------------|----------------------|----------------|-------------------------|---------------------------|----------------|---------------------|
| 3 | 1-1/4 | Conductive Rubber | 165 | 4-5/16" (109) | 2-29/32" (74) | Annular Ball | CH-03CRB-125-SW-___ |
| 3 | 1-1/4 | Thermoplastic Rubber | 165 | 4-5/16" (109) | 2-29/32" (74) | Precision Ball | CH-03TPP-125-SW-___ |
| 3 | 1-1/4 | Anti-Microbial TPR | 165 | 4-5/16" (109) | 2-29/32" (74) | Precision Ball | CH-03AMP-125-SW-___ |
| 3 | 1-1/4 | Polyurethane TPU | 165 | 4-5/16" (109) | 2-29/32" (74) | Precision Ball | CH-03PYP-125-SW-___ |
| 4 | 1-1/4 | Conductive Rubber | 165 | 5-5/16" (135) | 3-37/64" (91) | Annular Ball | CH-04CRB-125-SW-___ |
| 4 | 1-1/4 | Thermoplastic Rubber | 190 | 5-5/16" (135) | 3-37/64" (91) | Precision Ball | CH-04TPP-125-SW-___ |
| 4 | 1-1/4 | Anti-Microbial TPR | 190 | 5-5/16" (135) | 3-37/64" (91) | Precision Ball | CH-04AMP-125-SW-___ |
| 4 | 1-1/4 | Polyurethane TPU | 190 | 5-5/16" (135) | 3-37/64" (91) | Precision Ball | CH-04PYP-125-SW-___ |
| 5 | 1-1/4 | Conductive Rubber | 220 | 6-5/16" (160) | 4-7/32" (108) | Annular Ball | CH-05CRB-125-SW-___ |
| 5 | 1-1/4 | Thermoplastic Rubber | 220 | 6-5/16" (160) | 4-7/32" (108) | Precision Ball | CH-05TPP-125-SW-___ |
| 5 | 1-1/4 | Anti-Microbial TPR | 220 | 6-5/16" (160) | 4-7/32" (108) | Precision Ball | CH-05AMP-125-SW-___ |
| 5 | 1-1/4 | Polyurethane TPU | 220 | 6-5/16" (160) | 4-7/32" (108) | Precision Ball | CH-05PYP-125-SW-___ |
| 6 | 1-1/4 | Conductive Rubber | 240 | 7-9/32" (185) | 4-39/64 (117) | Annular Ball | CH-06CRB-125-SW-___ |
| 6 | 1-1/4 | Thermoplastic Rubber | 240 | 7-9/32" (185) | 4-39/64 (117) | Precision Ball | CH-06TPP-125-SW-___ |
| 6 | 1-1/4 | Anti-Microbial TPR | 240 | 7-9/32" (185) | 4-39/64 (117) | Precision Ball | CH-06AMP-125-SW-___ |
| 6 | 1-1/4 | Polyurethane TPU | 240 | 7-9/32" (185) | 4-39/64 (117) | Precision Ball | CH-06PYP-125-SW-___ |



Anti-Microbial wheels have light green tread.



Specify Grip Ring Stem (GR) code, see fittings at left for dimensions.

GRIP RING STEM FITTINGS

See fittings page for more options.

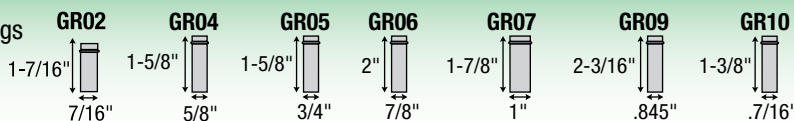

CHROME HOSPITAL (CH)

GRIP RING STEM TOTAL LOCK MODELS (LOCKS WHEEL AND SWIVEL)

| Wheel Diameter (Inches) | Tread Width (Inches) | Wheel Description | Capacity (Lbs) | Load Height Inches (mm) | Swivel Radius Inches (mm) | Wheel Bearing | Model Number |
|-------------------------|----------------------|----------------------|----------------|-------------------------|---------------------------|----------------|----------------------|
| 3 | 1-1/4 | Conductive Rubber | 165 | 4-5/16" (109) | 4-1/4" (108) | Precision Ball | CH-03CRB-125-TL-____ |
| 3 | 1-1/4 | Thermoplastic Rubber | 165 | 4-5/16" (109) | 4-1/4" (108) | Precision Ball | CH-03TPP-125-TL-____ |
| 3 | 1-1/4 | Anti-Microbial TPR | 165 | 4-5/16" (109) | 4-1/4" (108) | Precision Ball | CH-03AMP-125-TL-____ |
| 3 | 1-1/4 | Polyurethane TPU | 165 | 4-5/16" (109) | 4-1/4" (108) | Precision Ball | CH-03PYP-125-TL-____ |
| 4 | 1-1/4 | Conductive Rubber | 190 | 5-5/16" (135) | 4-35/64" (115) | Precision Ball | CH-04CRB-125-TL-____ |
| 4 | 1-1/4 | Thermoplastic Rubber | 190 | 5-5/16" (135) | 4-35/64" (115) | Precision Ball | CH-04TPP-125-TL-____ |
| 4 | 1-1/4 | Anti-Microbial TPR | 190 | 5-5/16" (135) | 4-35/64" (115) | Precision Ball | CH-04AMP-125-TL-____ |
| 4 | 1-1/4 | Polyurethane TPU | 190 | 5-5/16" (135) | 4-35/64" (115) | Precision Ball | CH-04PYP-125-TL-____ |
| 5 | 1-1/4 | Conductive Rubber | 220 | 6-5/16" (160) | 4-55/64" (123) | Precision Ball | CH-05CRB-125-TL-____ |
| 5 | 1-1/4 | Thermoplastic Rubber | 220 | 6-5/16" (160) | 4-55/64" (123) | Precision Ball | CH-05TPP-125-TL-____ |
| 5 | 1-1/4 | Anti-Microbial TPR | 220 | 6-5/16" (160) | 4-55/64" (123) | Precision Ball | CH-05AMP-125-TL-____ |
| 5 | 1-1/4 | Polyurethane TPU | 220 | 6-5/16" (160) | 4-55/64" (123) | Precision Ball | CH-05PYP-125-TL-____ |
| 6 | 1-1/4 | Conductive Rubber | 240 | 7-9/32" (185) | 4-55/64" (123) | Precision Ball | CH-06CRB-125-TL-____ |
| 6 | 1-1/4 | Thermoplastic Rubber | 240 | 7-9/32" (185) | 4-55/64" (123) | Precision Ball | CH-06TPP-125-TL-____ |
| 6 | 1-1/4 | Anti-Microbial TPR | 240 | 7-9/32" (185) | 4-55/64" (123) | Precision Ball | CH-06AMP-125-TL-____ |
| 6 | 1-1/4 | Polyurethane TPU | 240 | 7-9/32" (185) | 4-55/64" (123) | Precision Ball | CH-06PYP-125-TL-____ |



Total Lock
Change "SW"
to "TL". Red
sticker on pedal.

GRIP RING STEM DIRECTION LOCK MODELS (LOCKS SWIVEL ONLY)

| Wheel Diameter (Inches) | Tread Width (Inches) | Wheel Description | Capacity (Lbs) | Load Height Inches (mm) | Swivel Radius Inches (mm) | Wheel Bearing | Model Number |
|-------------------------|----------------------|----------------------|----------------|-------------------------|---------------------------|----------------|----------------------|
| 3 | 1-1/4 | Conductive Rubber | 165 | 4-5/16" (109) | 4-1/4" (108) | Precision Ball | CH-03CRB-125-DL-____ |
| 3 | 1-1/4 | Thermoplastic Rubber | 165 | 4-5/16" (109) | 4-1/4" (108) | Precision Ball | CH-03TPP-125-DL-____ |
| 3 | 1-1/4 | Anti-Microbial TPR | 165 | 4-5/16" (109) | 4-1/4" (108) | Precision Ball | CH-03AMP-125-DL-____ |
| 3 | 1-1/4 | Polyurethane TPU | 165 | 4-5/16" (109) | 4-1/4" (108) | Precision Ball | CH-03PYP-125-DL-____ |
| 4 | 1-1/4 | Conductive Rubber | 190 | 5-5/16" (135) | 4-35/64" (115) | Precision Ball | CH-04CRB-125-DL-____ |
| 4 | 1-1/4 | Thermoplastic Rubber | 190 | 5-5/16" (135) | 4-35/64" (115) | Precision Ball | CH-04TPP-125-DL-____ |
| 4 | 1-1/4 | Anti-Microbial TPR | 190 | 5-5/16" (135) | 4-35/64" (115) | Precision Ball | CH-04AMP-125-DL-____ |
| 4 | 1-1/4 | Polyurethane TPU | 190 | 5-5/16" (135) | 4-35/64" (115) | Precision Ball | CH-04PYP-125-DL-____ |
| 5 | 1-1/4 | Conductive Rubber | 220 | 6-5/16" (160) | 4-55/64" (123) | Precision Ball | CH-05CRB-125-DL-____ |
| 5 | 1-1/4 | Thermoplastic Rubber | 220 | 6-5/16" (160) | 4-55/64" (123) | Precision Ball | CH-05TPP-125-DL-____ |
| 5 | 1-1/4 | Anti-Microbial TPR | 220 | 6-5/16" (160) | 4-55/64" (123) | Precision Ball | CH-05AMP-125-DL-____ |
| 5 | 1-1/4 | Polyurethane TPU | 220 | 6-5/16" (160) | 4-55/64" (123) | Precision Ball | CH-05PYP-125-DL-____ |
| 6 | 1-1/4 | Conductive Rubber | 240 | 7-9/32" (185) | 4-55/64" (123) | Precision Ball | CH-06CRB-125-DL-____ |
| 6 | 1-1/4 | Thermoplastic Rubber | 240 | 7-9/32" (185) | 4-55/64" (123) | Precision Ball | CH-06TPP-125-DL-____ |
| 6 | 1-1/4 | Anti-Microbial TPR | 240 | 7-9/32" (185) | 4-55/64" (123) | Precision Ball | CH-06AMP-125-DL-____ |
| 6 | 1-1/4 | Polyurethane TPU | 240 | 7-9/32" (185) | 4-55/64" (123) | Precision Ball | CH-06PYP-125-DL-____ |



Direction Lock
Change "SW"
to "DL". Green
sticker on pedal.

Specify Grip Ring Stem (GR) code, see fittings at left for dimensions.

GRIP RING STEM FITTINGS

See fittings page for more options.

| Fitting Code | Height (Inches) | Width (Inches) |
|--------------|-----------------|----------------|
| GR02 | 1-7/16" | 7/16" |
| GR04 | 1-5/8" | 5/8" |
| GR05 | 1-5/8" | 3/4" |
| GR06 | 2" | 7/8" |
| GR07 | 1-7/8" | 1" |
| GR09 | 2-3/16" | .845" |
| GR10 | 1-3/8" | .7/16" |

CHROME HOSPITAL (CH)

EXPANDING ADAPTER STEM MODELS
FREE SWIVEL • TOTAL LOCK • DIRECTION LOCK



APPLICATIONS

- Food Service
- Case Carts
- Utility Carts
- Hospital Equipment
- Institutional Equipment
- Store Fixtures
- Medical equipment

New larger brake pedal for easy braking action

FEATURES

- Chrome Plated Finish
- Dual Ball Swivel Raceways for added strength
- Total Lock Brake models lock both swivel and wheel
- Directional lock models lock swivel only (helps with steering)
- Precision ball bearings in wheels for easier rollability
- Wheels have full thread guards for added protection

The CH series brings you Chrome Hospital casters at an affordable price.

EXPANDING ADAPTER STEM MODELS

| Wheel Diameter (Inches) | Tread Width (Inches) | Wheel Description | Capacity (Lbs) | Load Height Inches (mm) | Swivel Radius Inches (mm) | Wheel Bearing | Model Number |
|-------------------------|----------------------|----------------------|----------------|-------------------------|---------------------------|----------------|---------------------|
| 3 | 1-1/4 | Conductive Rubber | 165 | 4-5/16" (109) | 2-29/32" (74) | Annular Ball | CH-03CRB-125-SW-___ |
| 3 | 1-1/4 | Thermoplastic Rubber | 165 | 4-5/16" (109) | 2-29/32" (74) | Precision Ball | CH-03TPP-125-SW-___ |
| 3 | 1-1/4 | Anti-Microbial TPR | 165 | 4-5/16" (109) | 2-29/32" (74) | Precision Ball | CH-03AMP-125-SW-___ |
| 3 | 1-1/4 | Polyurethane TPU | 165 | 4-5/16" (109) | 2-29/32" (74) | Precision Ball | CH-03PYP-125-SW-___ |
| 4 | 1-1/4 | Conductive Rubber | 165 | 5-5/16" (135) | 3-37/64" (91) | Annular Ball | CH-04CRB-125-SW-___ |
| 4 | 1-1/4 | Thermoplastic Rubber | 190 | 5-5/16" (135) | 3-37/64" (91) | Precision Ball | CH-04TPP-125-SW-___ |
| 4 | 1-1/4 | Anti-Microbial TPR | 190 | 5-5/16" (135) | 3-37/64" (91) | Precision Ball | CH-04AMP-125-SW-___ |
| 4 | 1-1/4 | Polyurethane TPU | 190 | 5-5/16" (135) | 3-37/64" (91) | Precision Ball | CH-04PYP-125-SW-___ |
| 5 | 1-1/4 | Conductive Rubber | 220 | 6-5/16" (160) | 4-7/32" (108) | Annular Ball | CH-05CRB-125-SW-___ |
| 5 | 1-1/4 | Thermoplastic Rubber | 220 | 6-5/16" (160) | 4-7/32" (108) | Precision Ball | CH-05TPP-125-SW-___ |
| 5 | 1-1/4 | Anti-Microbial TPR | 220 | 6-5/16" (160) | 4-7/32" (108) | Precision Ball | CH-05AMP-125-SW-___ |
| 5 | 1-1/4 | Polyurethane TPU | 220 | 6-5/16" (160) | 4-7/32" (108) | Precision Ball | CH-05PYP-125-SW-___ |
| 6 | 1-1/4 | Conductive Rubber | 240 | 7-9/32" (185) | 4-39/64 (117) | Annular Ball | CH-06CRB-125-SW-___ |
| 6 | 1-1/4 | Thermoplastic Rubber | 240 | 7-9/32" (185) | 4-39/64 (117) | Precision Ball | CH-06TPP-125-SW-___ |
| 6 | 1-1/4 | Anti-Microbial TPR | 240 | 7-9/32" (185) | 4-39/64 (117) | Precision Ball | CH-06AMP-125-SW-___ |
| 6 | 1-1/4 | Polyurethane TPU | 240 | 7-9/32" (185) | 4-39/64 (117) | Precision Ball | CH-06PYP-125-SW-___ |



Anti-Microbial wheels have light green tread.



Specify Expanding Adapter Stem (XR) code, see fittings at left for dimensions.

EXPANDING ADAPTER STEM FITTINGS

See fittings page for descriptions and more options.

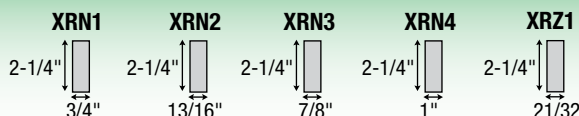

CHROME HOSPITAL (CH)

EXPANDING ADAPTER STEM TOTAL LOCK MODELS (LOCKS WHEEL AND SWIVEL)

| Wheel Diameter (Inches) | Tread Width (Inches) | Wheel Description | Capacity (Lbs) | Load Height Inches (mm) | Swivel Radius Inches (mm) | Wheel Bearing | Model Number |
|-------------------------|----------------------|----------------------|----------------|-------------------------|---------------------------|----------------|-----------------------|
| 3 | 1-1/4 | Conductive Rubber | 165 | 4-5/16" (109) | 4-1/4" (108) | Precision Ball | CH-03CRB-125-TL-_____ |
| 3 | 1-1/4 | Thermoplastic Rubber | 165 | 4-5/16" (109) | 4-1/4" (108) | Precision Ball | CH-03TPP-125-TL-_____ |
| 3 | 1-1/4 | Anti-Microbial TPR | 165 | 4-5/16" (109) | 4-1/4" (108) | Precision Ball | CH-03AMP-125-TL-_____ |
| 3 | 1-1/4 | Polyurethane TPU | 165 | 4-5/16" (109) | 4-1/4" (108) | Precision Ball | CH-03PYP-125-TL-_____ |
| 4 | 1-1/4 | Conductive Rubber | 190 | 5-5/16" (135) | 4-35/64" (115) | Precision Ball | CH-04CRB-125-TL-_____ |
| 4 | 1-1/4 | Thermoplastic Rubber | 190 | 5-5/16" (135) | 4-35/64" (115) | Precision Ball | CH-04TPP-125-TL-_____ |
| 4 | 1-1/4 | Anti-Microbial TPR | 190 | 5-5/16" (135) | 4-35/64" (115) | Precision Ball | CH-04AMP-125-TL-_____ |
| 4 | 1-1/4 | Polyurethane TPU | 190 | 5-5/16" (135) | 4-35/64" (115) | Precision Ball | CH-04PYP-125-TL-_____ |
| 5 | 1-1/4 | Conductive Rubber | 220 | 6-5/16" (160) | 4-55/64" (123) | Precision Ball | CH-05CRB-125-TL-_____ |
| 5 | 1-1/4 | Thermoplastic Rubber | 220 | 6-5/16" (160) | 4-55/64" (123) | Precision Ball | CH-05TPP-125-TL-_____ |
| 5 | 1-1/4 | Anti-Microbial TPR | 220 | 6-5/16" (160) | 4-55/64" (123) | Precision Ball | CH-05AMP-125-TL-_____ |
| 5 | 1-1/4 | Polyurethane TPU | 220 | 6-5/16" (160) | 4-55/64" (123) | Precision Ball | CH-05PYP-125-TL-_____ |
| 6 | 1-1/4 | Conductive Rubber | 240 | 7-9/32" (185) | 4-55/64" (123) | Precision Ball | CH-06CRB-125-TL-_____ |
| 6 | 1-1/4 | Thermoplastic Rubber | 240 | 7-9/32" (185) | 4-55/64" (123) | Precision Ball | CH-06TPP-125-TL-_____ |
| 6 | 1-1/4 | Anti-Microbial TPR | 240 | 7-9/32" (185) | 4-55/64" (123) | Precision Ball | CH-06AMP-125-TL-_____ |
| 6 | 1-1/4 | Polyurethane TPU | 240 | 7-9/32" (185) | 4-55/64" (123) | Precision Ball | CH-06PYP-125-TL-_____ |



Total Lock
Change "SW"
to "TL". Red
sticker on pedal.

EXPANDING ADAPTER STEM DIRECTION LOCK MODELS (LOCKS SWIVEL ONLY)

| Wheel Diameter (Inches) | Tread Width (Inches) | Wheel Description | Capacity (Lbs) | Load Height Inches (mm) | Swivel Radius Inches (mm) | Wheel Bearing | Model Number |
|-------------------------|----------------------|----------------------|----------------|-------------------------|---------------------------|----------------|-----------------------|
| 3 | 1-1/4 | Conductive Rubber | 165 | 4-5/16" (109) | 4-1/4" (108) | Precision Ball | CH-03CRB-125-DL-_____ |
| 3 | 1-1/4 | Thermoplastic Rubber | 165 | 4-5/16" (109) | 4-1/4" (108) | Precision Ball | CH-03TPP-125-DL-_____ |
| 3 | 1-1/4 | Anti-Microbial TPR | 165 | 4-5/16" (109) | 4-1/4" (108) | Precision Ball | CH-03AMP-125-DL-_____ |
| 3 | 1-1/4 | Polyurethane TPU | 165 | 4-5/16" (109) | 4-1/4" (108) | Precision Ball | CH-03PYP-125-DL-_____ |
| 4 | 1-1/4 | Conductive Rubber | 190 | 5-5/16" (135) | 4-35/64" (115) | Precision Ball | CH-04CRB-125-DL-_____ |
| 4 | 1-1/4 | Thermoplastic Rubber | 190 | 5-5/16" (135) | 4-35/64" (115) | Precision Ball | CH-04TPP-125-DL-_____ |
| 4 | 1-1/4 | Anti-Microbial TPR | 190 | 5-5/16" (135) | 4-35/64" (115) | Precision Ball | CH-04AMP-125-DL-_____ |
| 4 | 1-1/4 | Polyurethane TPU | 190 | 5-5/16" (135) | 4-35/64" (115) | Precision Ball | CH-04PYP-125-DL-_____ |
| 5 | 1-1/4 | Conductive Rubber | 220 | 6-5/16" (160) | 4-55/64" (123) | Precision Ball | CH-05CRB-125-DL-_____ |
| 5 | 1-1/4 | Thermoplastic Rubber | 220 | 6-5/16" (160) | 4-55/64" (123) | Precision Ball | CH-05TPP-125-DL-_____ |
| 5 | 1-1/4 | Anti-Microbial TPR | 220 | 6-5/16" (160) | 4-55/64" (123) | Precision Ball | CH-05AMP-125-DL-_____ |
| 5 | 1-1/4 | Polyurethane TPU | 220 | 6-5/16" (160) | 4-55/64" (123) | Precision Ball | CH-05PYP-125-DL-_____ |
| 6 | 1-1/4 | Conductive Rubber | 240 | 7-9/32" (185) | 4-55/64" (123) | Precision Ball | CH-06CRB-125-DL-_____ |
| 6 | 1-1/4 | Thermoplastic Rubber | 240 | 7-9/32" (185) | 4-55/64" (123) | Precision Ball | CH-06TPP-125-DL-_____ |
| 6 | 1-1/4 | Anti-Microbial TPR | 240 | 7-9/32" (185) | 4-55/64" (123) | Precision Ball | CH-06AMP-125-DL-_____ |
| 6 | 1-1/4 | Polyurethane TPU | 240 | 7-9/32" (185) | 4-55/64" (123) | Precision Ball | CH-06PYP-125-DL-_____ |



Direction Lock
Change "SW"
to "DL". Green
sticker on pedal.

Specify Expanding Adapter Stem (XR) code, see fittings at left for dimensions.

EXPANDING ADAPTER STEM FITTINGS

See fittings page for descriptions and more options.

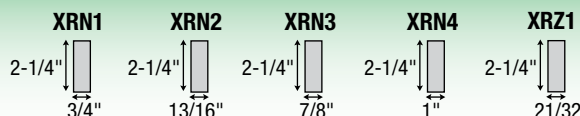

CHROME HOSPITAL (CH)

THREADED STEM MODELS

FREE SWIVEL • TOTAL LOCK • DIRECTION LOCK



APPLICATIONS

- Food Service
- Case Carts
- Utility Carts
- Hospital Equipment
- Institutional Equipment
- Store Fixtures
- Medical equipment

New larger brake pedal for easy braking action

FEATURES

- Chrome Plated Finish
- Dual Ball Swivel Raceways for added strength
- Total Lock Brake models lock both swivel and wheel
- Directional lock models lock swivel only (helps with Steering)
- Precision ball bearings in wheels for easier rollability
- Wheels have full thread guards for added protection

The CH series brings you Chrome Hospital casters at an affordable price.

THREADED STEM MODELS

| Wheel Diameter (Inches) | Tread Width (Inches) | Wheel Description | Capacity (Lbs) | Load Height Inches (mm) | Swivel Radius Inches (mm) | Wheel Bearing | Model Number |
|-------------------------|----------------------|----------------------|----------------|-------------------------|---------------------------|----------------|----------------------|
| 3 | 1-1/4 | Conductive Rubber | 165 | 4-5/16" (109) | 2-29/32" (74) | Annular Ball | CH-03CRB-125-SW-____ |
| 3 | 1-1/4 | Thermoplastic Rubber | 165 | 4-5/16" (109) | 2-29/32" (74) | Precision Ball | CH-03TPP-125-SW-____ |
| 3 | 1-1/4 | Anti-Microbial TPR | 165 | 4-5/16" (109) | 2-29/32" (74) | Precision Ball | CH-03AMP-125-SW-____ |
| 3 | 1-1/4 | Polyurethane TPU | 165 | 4-5/16" (109) | 2-29/32" (74) | Precision Ball | CH-03PYP-125-SW-____ |
| 4 | 1-1/4 | Conductive Rubber | 165 | 5-5/16" (135) | 3-37/64" (91) | Annular Ball | CH-04CRB-125-SW-____ |
| 4 | 1-1/4 | Thermoplastic Rubber | 190 | 5-5/16" (135) | 3-37/64" (91) | Precision Ball | CH-04TPP-125-SW-____ |
| 4 | 1-1/4 | Anti-Microbial TPR | 190 | 5-5/16" (135) | 3-37/64" (91) | Precision Ball | CH-04AMP-125-SW-____ |
| 4 | 1-1/4 | Polyurethane TPU | 190 | 5-5/16" (135) | 3-37/64" (91) | Precision Ball | CH-04PYP-125-SW-____ |
| 5 | 1-1/4 | Conductive Rubber | 220 | 6-5/16" (160) | 4-7/32" (108) | Annular Ball | CH-05CRB-125-SW-____ |
| 5 | 1-1/4 | Thermoplastic Rubber | 220 | 6-5/16" (160) | 4-7/32" (108) | Precision Ball | CH-05TPP-125-SW-____ |
| 5 | 1-1/4 | Anti-Microbial TPR | 220 | 6-5/16" (160) | 4-7/32" (108) | Precision Ball | CH-05AMP-125-SW-____ |
| 5 | 1-1/4 | Polyurethane TPU | 220 | 6-5/16" (160) | 4-7/32" (108) | Precision Ball | CH-05PYP-125-SW-____ |
| 6 | 1-1/4 | Conductive Rubber | 240 | 7-9/32" (185) | 4-39/64 (117) | Annular Ball | CH-06CRB-125-SW-____ |
| 6 | 1-1/4 | Thermoplastic Rubber | 240 | 7-9/32" (185) | 4-39/64 (117) | Precision Ball | CH-06TPP-125-SW-____ |
| 6 | 1-1/4 | Anti-Microbial TPR | 240 | 7-9/32" (185) | 4-39/64 (117) | Precision Ball | CH-06AMP-125-SW-____ |
| 6 | 1-1/4 | Polyurethane TPU | 240 | 7-9/32" (185) | 4-39/64 (117) | Precision Ball | CH-06PYP-125-SW-____ |



Anti-Microbial wheels have light green tread.



Specify Threaded Stem (TS) code, see fittings at left for dimensions:

THREADED STEM FITTINGS

See fittings page for more easy to install stem options.

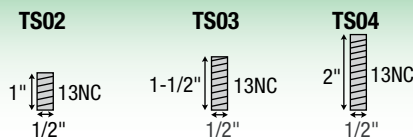

CHROME HOSPITAL (CH)

THREADED STEM TOTAL LOCK MODELS (LOCKS WHEEL AND SWIVEL)

| Wheel Diameter (Inches) | Tread Width (Inches) | Wheel Description | Capacity (Lbs) | Load Height Inches (mm) | Swivel Radius Inches (mm) | Wheel Bearing | Model Number |
|-------------------------|----------------------|----------------------|----------------|-------------------------|---------------------------|----------------|-----------------------|
| 3 | 1-1/4 | Conductive Rubber | 165 | 4-5/16" (109) | 4-1/4" (108) | Precision Ball | CH-03CRB-125-TL-_____ |
| 3 | 1-1/4 | Thermoplastic Rubber | 165 | 4-5/16" (109) | 4-1/4" (108) | Precision Ball | CH-03TPP-125-TL-_____ |
| 3 | 1-1/4 | Anti-Microbial TPR | 165 | 4-5/16" (109) | 4-1/4" (108) | Precision Ball | CH-03AMP-125-TL-_____ |
| 3 | 1-1/4 | Polyurethane TPU | 165 | 4-5/16" (109) | 4-1/4" (108) | Precision Ball | CH-03PYP-125-TL-_____ |
| 4 | 1-1/4 | Conductive Rubber | 190 | 5-5/16" (135) | 4-35/64" (115) | Precision Ball | CH-04CRB-125-TL-_____ |
| 4 | 1-1/4 | Thermoplastic Rubber | 190 | 5-5/16" (135) | 4-35/64" (115) | Precision Ball | CH-04TPP-125-TL-_____ |
| 4 | 1-1/4 | Anti-Microbial TPR | 190 | 5-5/16" (135) | 4-35/64" (115) | Precision Ball | CH-04AMP-125-TL-_____ |
| 4 | 1-1/4 | Polyurethane TPU | 190 | 5-5/16" (135) | 4-35/64" (115) | Precision Ball | CH-04PYP-125-TL-_____ |
| 5 | 1-1/4 | Conductive Rubber | 220 | 6-5/16" (160) | 4-55/64" (123) | Precision Ball | CH-05CRB-125-TL-_____ |
| 5 | 1-1/4 | Thermoplastic Rubber | 220 | 6-5/16" (160) | 4-55/64" (123) | Precision Ball | CH-05TPP-125-TL-_____ |
| 5 | 1-1/4 | Anti-Microbial TPR | 220 | 6-5/16" (160) | 4-55/64" (123) | Precision Ball | CH-05AMP-125-TL-_____ |
| 5 | 1-1/4 | Polyurethane TPU | 220 | 6-5/16" (160) | 4-55/64" (123) | Precision Ball | CH-05PYP-125-TL-_____ |
| 6 | 1-1/4 | Conductive Rubber | 240 | 7-9/32" (185) | 4-55/64" (123) | Precision Ball | CH-06CRB-125-TL-_____ |
| 6 | 1-1/4 | Thermoplastic Rubber | 240 | 7-9/32" (185) | 4-55/64" (123) | Precision Ball | CH-06TPP-125-TL-_____ |
| 6 | 1-1/4 | Anti-Microbial TPR | 240 | 7-9/32" (185) | 4-55/64" (123) | Precision Ball | CH-06AMP-125-TL-_____ |
| 6 | 1-1/4 | Polyurethane TPU | 240 | 7-9/32" (185) | 4-55/64" (123) | Precision Ball | CH-06PYP-125-TL-_____ |



Total Lock
Change "SW"
to "TL". **Red**
sticker on pedal.

THREADED STEM DIRECTION LOCK MODELS (LOCKS SWIVEL ONLY)

| Wheel Diameter (Inches) | Tread Width (Inches) | Wheel Description | Capacity (Lbs) | Load Height Inches (mm) | Swivel Radius Inches (mm) | Wheel Bearing | Model Number |
|-------------------------|----------------------|----------------------|----------------|-------------------------|---------------------------|----------------|-----------------------|
| 3 | 1-1/4 | Conductive Rubber | 165 | 4-5/16" (109) | 4-1/4" (108) | Precision Ball | CH-03CRB-125-DL-_____ |
| 3 | 1-1/4 | Thermoplastic Rubber | 165 | 4-5/16" (109) | 4-1/4" (108) | Precision Ball | CH-03TPP-125-DL-_____ |
| 3 | 1-1/4 | Anti-Microbial TPR | 165 | 4-5/16" (109) | 4-1/4" (108) | Precision Ball | CH-03AMP-125-DL-_____ |
| 3 | 1-1/4 | Polyurethane TPU | 165 | 4-5/16" (109) | 4-1/4" (108) | Precision Ball | CH-03PYP-125-DL-_____ |
| 4 | 1-1/4 | Conductive Rubber | 190 | 5-5/16" (135) | 4-35/64" (115) | Precision Ball | CH-04CRB-125-DL-_____ |
| 4 | 1-1/4 | Thermoplastic Rubber | 190 | 5-5/16" (135) | 4-35/64" (115) | Precision Ball | CH-04TPP-125-DL-_____ |
| 4 | 1-1/4 | Anti-Microbial TPR | 190 | 5-5/16" (135) | 4-35/64" (115) | Precision Ball | CH-04AMP-125-DL-_____ |
| 4 | 1-1/4 | Polyurethane TPU | 190 | 5-5/16" (135) | 4-35/64" (115) | Precision Ball | CH-04PYP-125-DL-_____ |
| 5 | 1-1/4 | Conductive Rubber | 220 | 6-5/16" (160) | 4-55/64" (123) | Precision Ball | CH-05CRB-125-DL-_____ |
| 5 | 1-1/4 | Thermoplastic Rubber | 220 | 6-5/16" (160) | 4-55/64" (123) | Precision Ball | CH-05TPP-125-DL-_____ |
| 5 | 1-1/4 | Anti-Microbial TPR | 220 | 6-5/16" (160) | 4-55/64" (123) | Precision Ball | CH-05AMP-125-DL-_____ |
| 5 | 1-1/4 | Polyurethane TPU | 220 | 6-5/16" (160) | 4-55/64" (123) | Precision Ball | CH-05PYP-125-DL-_____ |
| 6 | 1-1/4 | Conductive Rubber | 240 | 7-9/32" (185) | 4-55/64" (123) | Precision Ball | CH-06CRB-125-DL-_____ |
| 6 | 1-1/4 | Thermoplastic Rubber | 240 | 7-9/32" (185) | 4-55/64" (123) | Precision Ball | CH-06TPP-125-DL-_____ |
| 6 | 1-1/4 | Anti-Microbial TPR | 240 | 7-9/32" (185) | 4-55/64" (123) | Precision Ball | CH-06AMP-125-DL-_____ |
| 6 | 1-1/4 | Polyurethane TPU | 240 | 7-9/32" (185) | 4-55/64" (123) | Precision Ball | CH-06PYP-125-DL-_____ |



Direction Lock
Change "SW"
to "DL". **Green**
sticker on pedal.

Specify Threaded Stem
(TS) code, see fittings at
left for dimensions:

THREADED STEM FITTINGS

See fittings page for
more easy to install
stem options.

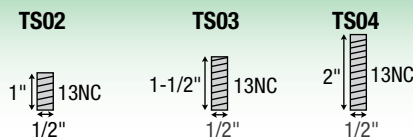

CHROME HOSPITAL (CH)

ROUND/SQUARE STEM MODELS
FREE SWIVEL • TOTAL LOCK • DIRECTION LOCK



- APPLICATIONS**
- Food Service
 - Case Carts
 - Utility Carts
 - Hospital Equipment
 - Institutional Equipment
 - Store Fixtures
 - Medical equipment

New larger brake pedal for easy braking action

- FEATURES**
- Chrome Plated Finish
 - Dual Ball Swivel Raceways for added strength
 - Total Lock Brake models lock both swivel and wheel
 - Directional lock models lock swivel only (helps with steering)
 - Precision ball bearings in wheels for easier rollability
 - Wheels have full thread guards for added protection

The CH series brings you Chrome Hospital casters at an affordable price.

SQUARE/ROUND STEM FREE SWIVEL MODELS

| Wheel Diameter (Inches) | Tread Width (Inches) | Wheel Description | Capacity (Lbs) | Load Height Inches (mm) | Swivel Radius Inches (mm) | Wheel Bearing | Model Number |
|-------------------------|----------------------|----------------------|----------------|-------------------------|---------------------------|----------------|---------------------|
| 3 | 1-1/4 | Conductive Rubber | 165 | 4-5/16" (109) | 2-29/32" (74) | Annular Ball | CH-03CRB-125-SW-___ |
| 3 | 1-1/4 | Thermoplastic Rubber | 165 | 4-5/16" (109) | 2-29/32" (74) | Precision Ball | CH-03TPP-125-SW-___ |
| 3 | 1-1/4 | Anti-Microbial TPR | 165 | 4-5/16" (109) | 2-29/32" (74) | Precision Ball | CH-03AMP-125-SW-___ |
| 3 | 1-1/4 | Polyurethane TPU | 165 | 4-5/16" (109) | 2-29/32" (74) | Precision Ball | CH-03PYP-125-SW-___ |
| 4 | 1-1/4 | Conductive Rubber | 165 | 5-5/16" (135) | 3-37/64" (91) | Annular Ball | CH-04CRB-125-SW-___ |
| 4 | 1-1/4 | Thermoplastic Rubber | 190 | 5-5/16" (135) | 3-37/64" (91) | Precision Ball | CH-04TPP-125-SW-___ |
| 4 | 1-1/4 | Anti-Microbial TPR | 190 | 5-5/16" (135) | 3-37/64" (91) | Precision Ball | CH-04AMP-125-SW-___ |
| 4 | 1-1/4 | Polyurethane TPU | 190 | 5-5/16" (135) | 3-37/64" (91) | Precision Ball | CH-04PYP-125-SW-___ |
| 5 | 1-1/4 | Conductive Rubber | 220 | 6-5/16" (160) | 4-7/32" (108) | Annular Ball | CH-05CRB-125-SW-___ |
| 5 | 1-1/4 | Thermoplastic Rubber | 220 | 6-5/16" (160) | 4-7/32" (108) | Precision Ball | CH-05TPP-125-SW-___ |
| 5 | 1-1/4 | Anti-Microbial TPR | 220 | 6-5/16" (160) | 4-7/32" (108) | Precision Ball | CH-05AMP-125-SW-___ |
| 5 | 1-1/4 | Polyurethane TPU | 220 | 6-5/16" (160) | 4-7/32" (108) | Precision Ball | CH-05PYP-125-SW-___ |
| 6 | 1-1/4 | Conductive Rubber | 240 | 7-9/32" (185) | 4-39/64 (117) | Annular Ball | CH-06CRB-125-SW-___ |
| 6 | 1-1/4 | Thermoplastic Rubber | 240 | 7-9/32" (185) | 4-39/64 (117) | Precision Ball | CH-06TPP-125-SW-___ |
| 6 | 1-1/4 | Anti-Microbial TPR | 240 | 7-9/32" (185) | 4-39/64 (117) | Precision Ball | CH-06AMP-125-SW-___ |
| 6 | 1-1/4 | Polyurethane TPU | 240 | 7-9/32" (185) | 4-39/64 (117) | Precision Ball | CH-06PYP-125-SW-___ |



Rigid models available. Consult factory.

Anti-Microbial wheels have light green tread.



ROUND STEM FITTINGS

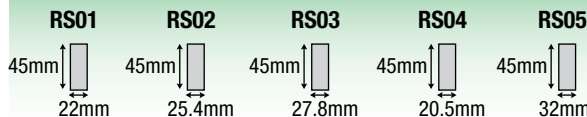

SQUARE STEM FITTINGS

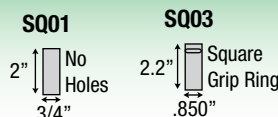

Specify Round Stem (RS) code, Square stem specify (SQ) code. see fittings at left for dimensions..

See fittings page for more options.



CHROME HOSPITAL (CH)

SQUARE/ROUND STEM TOTAL LOCK MODELS (LOCKS WHEEL AND SWIVEL)

| Wheel Diameter (Inches) | Tread Width (Inches) | Wheel Description | Capacity (Lbs) | Load Height Inches (mm) | Swivel Radius Inches (mm) | Wheel Bearing | Model Number |
|-------------------------|----------------------|----------------------|----------------|-------------------------|---------------------------|----------------|----------------------|
| 3 | 1-1/4 | Conductive Rubber | 165 | 4-5/16" (109) | 4-1/4" (108) | Precision Ball | CH-03CRB-125-TL-____ |
| 3 | 1-1/4 | Thermoplastic Rubber | 165 | 4-5/16" (109) | 4-1/4" (108) | Precision Ball | CH-03TPP-125-TL-____ |
| 3 | 1-1/4 | Anti-Microbial TPR | 165 | 4-5/16" (109) | 4-1/4" (108) | Precision Ball | CH-03AMP-125-TL-____ |
| 3 | 1-1/4 | Polyurethane TPU | 165 | 4-5/16" (109) | 4-1/4" (108) | Precision Ball | CH-03PYP-125-TL-____ |
| 4 | 1-1/4 | Conductive Rubber | 190 | 5-5/16" (135) | 4-35/64" (115) | Precision Ball | CH-04CRB-125-TL-____ |
| 4 | 1-1/4 | Thermoplastic Rubber | 190 | 5-5/16" (135) | 4-35/64" (115) | Precision Ball | CH-04TPP-125-TL-____ |
| 4 | 1-1/4 | Anti-Microbial TPR | 190 | 5-5/16" (135) | 4-35/64" (115) | Precision Ball | CH-04AMP-125-TL-____ |
| 4 | 1-1/4 | Polyurethane TPU | 190 | 5-5/16" (135) | 4-35/64" (115) | Precision Ball | CH-04PYP-125-TL-____ |
| 5 | 1-1/4 | Conductive Rubber | 220 | 6-5/16" (160) | 4-55/64" (123) | Precision Ball | CH-05CRB-125-TL-____ |
| 5 | 1-1/4 | Thermoplastic Rubber | 220 | 6-5/16" (160) | 4-55/64" (123) | Precision Ball | CH-05TPP-125-TL-____ |
| 5 | 1-1/4 | Anti-Microbial TPR | 220 | 6-5/16" (160) | 4-55/64" (123) | Precision Ball | CH-05AMP-125-TL-____ |
| 5 | 1-1/4 | Polyurethane TPU | 220 | 6-5/16" (160) | 4-55/64" (123) | Precision Ball | CH-05PYP-125-TL-____ |
| 6 | 1-1/4 | Conductive Rubber | 240 | 7-9/32" (185) | 4-55/64" (123) | Precision Ball | CH-06CRB-125-TL-____ |
| 6 | 1-1/4 | Thermoplastic Rubber | 240 | 7-9/32" (185) | 4-55/64" (123) | Precision Ball | CH-06TPP-125-TL-____ |
| 6 | 1-1/4 | Anti-Microbial TPR | 240 | 7-9/32" (185) | 4-55/64" (123) | Precision Ball | CH-06AMP-125-TL-____ |
| 6 | 1-1/4 | Polyurethane TPU | 240 | 7-9/32" (185) | 4-55/64" (123) | Precision Ball | CH-06PYP-125-TL-____ |



Total Lock
Change "SW" to "TL". Red sticker on pedal.

SQUARE/ROUND STEM DIRECTION LOCK MODELS (LOCKS SWIVEL ONLY)

| Wheel Diameter (Inches) | Tread Width (Inches) | Wheel Description | Capacity (Lbs) | Load Height Inches (mm) | Swivel Radius Inches (mm) | Wheel Bearing | Model Number |
|-------------------------|----------------------|----------------------|----------------|-------------------------|---------------------------|----------------|----------------------|
| 3 | 1-1/4 | Conductive Rubber | 165 | 4-5/16" (109) | 4-1/4" (108) | Precision Ball | CH-03CRB-125-DL-____ |
| 3 | 1-1/4 | Thermoplastic Rubber | 165 | 4-5/16" (109) | 4-1/4" (108) | Precision Ball | CH-03TPP-125-DL-____ |
| 3 | 1-1/4 | Anti-Microbial TPR | 165 | 4-5/16" (109) | 4-1/4" (108) | Precision Ball | CH-03AMP-125-DL-____ |
| 3 | 1-1/4 | Polyurethane TPU | 165 | 4-5/16" (109) | 4-1/4" (108) | Precision Ball | CH-03PYP-125-DL-____ |
| 4 | 1-1/4 | Conductive Rubber | 190 | 5-5/16" (135) | 4-35/64" (115) | Precision Ball | CH-04CRB-125-DL-____ |
| 4 | 1-1/4 | Thermoplastic Rubber | 190 | 5-5/16" (135) | 4-35/64" (115) | Precision Ball | CH-04TPP-125-DL-____ |
| 4 | 1-1/4 | Anti-Microbial TPR | 190 | 5-5/16" (135) | 4-35/64" (115) | Precision Ball | CH-04AMP-125-DL-____ |
| 4 | 1-1/4 | Polyurethane TPU | 190 | 5-5/16" (135) | 4-35/64" (115) | Precision Ball | CH-04PYP-125-DL-____ |
| 5 | 1-1/4 | Conductive Rubber | 220 | 6-5/16" (160) | 4-55/64" (123) | Precision Ball | CH-05CRB-125-DL-____ |
| 5 | 1-1/4 | Thermoplastic Rubber | 220 | 6-5/16" (160) | 4-55/64" (123) | Precision Ball | CH-05TPP-125-DL-____ |
| 5 | 1-1/4 | Anti-Microbial TPR | 220 | 6-5/16" (160) | 4-55/64" (123) | Precision Ball | CH-05AMP-125-DL-____ |
| 5 | 1-1/4 | Polyurethane TPU | 220 | 6-5/16" (160) | 4-55/64" (123) | Precision Ball | CH-05PYP-125-DL-____ |
| 6 | 1-1/4 | Conductive Rubber | 240 | 7-9/32" (185) | 4-55/64" (123) | Precision Ball | CH-06CRB-125-DL-____ |
| 6 | 1-1/4 | Thermoplastic Rubber | 240 | 7-9/32" (185) | 4-55/64" (123) | Precision Ball | CH-06TPP-125-DL-____ |
| 6 | 1-1/4 | Anti-Microbial TPR | 240 | 7-9/32" (185) | 4-55/64" (123) | Precision Ball | CH-06AMP-125-DL-____ |
| 6 | 1-1/4 | Polyurethane TPU | 240 | 7-9/32" (185) | 4-55/64" (123) | Precision Ball | CH-06PYP-125-DL-____ |



Direction Lock
Change "SW" to "DL". Green sticker on pedal.

ROUND STEM FITTINGS

| RS01 | RS02 | RS03 | RS04 | RS05 |
|--------------|----------------|----------------|----------------|--------------|
| 45mm 22mm | 45mm 25.4mm | 45mm 27.8mm | 45mm 20.5mm | 45mm 32mm |

SQUARE STEM FITTINGS

| SQ01 | SQ03 |
|---------------------|--------------------------------|
| 2" No Holes 3/4" | 2.2" Square Grip Ring .850" |

Specify Round Stem (RS) code, Square stem specify (SQ) code. see fittings at left for dimensions..

CHROME STEEL (CS)

SWIVEL TOP PLATE MODELS

FREE SWIVEL • TOTAL LOCK • DIRECTION LOCK



- APPLICATIONS**
- Food Service
 - Case Carts
 - Utility Carts
 - Medical Equipment
 - Institutional Equipment
 - Hospital Carts
 - Pharmaceutical Equipment

- FEATURES**
- Dual Ball Swivel Raceways for added strength
 - Total Lock Brake models lock both swivel and wheel
 - Directional lock models lock swivel only (helps with Steering)
 - Wheels available with Precision ball bearings or spanner bushing
 - Wheels with Precision Bearings have Full Plastic thread guards for added protection
 - Bright Chrome Finish

Chrome Steel casters that look and meet the European standards.

SWIVEL TOP PLATE MODELS

| Wheel Diameter inches (mm) | Tread Width (inches) | Wheel Description | Capacity (Lbs) | Load Height inches (mm) | Swivel Radius inches (mm) | Wheel Bearing | Model Number |
|----------------------------|----------------------|----------------------|----------------|-------------------------|---------------------------|----------------|----------------------|
| 4" (100) | 1-1/4 | Neoprene Rubber | 190 | 5-1/2" (140) | 3-15/32" (88) | Precision Ball | CS-04NRP-125-SW-TP01 |
| 4" (100) | 1-1/4 | Thermoplastic Rubber | 190 | 5-1/2" (140) | 3-15/32" (88) | Precision Ball | CS-04TPP-125-SW-TP01 |
| 4" (100) | 1-1/4 | Thermoplastic Rubber | 190 | 5-1/2" (140) | 3-15/32" (88) | Plain Bore | CS-04TPO-125-SW-TP01 |
| 4" (100) | 1-1/4 | Polyurethane TPU | 190 | 5-1/2" (140) | 3-15/32" (88) | Precision Ball | CS-04PYP-125-SW-TP01 |
| 5" (125) | 1-1/4 | Neoprene Rubber | 220 | 6-1/2" (165) | 4-3/32" (104) | Precision Ball | CS-05NRP-125-SW-TP01 |
| 5" (125) | 1-1/4 | Thermoplastic Rubber | 220 | 6-1/2" (165) | 4-3/32" (104) | Precision Ball | CS-05TPP-125-SW-TP01 |
| 5" (125) | 1-1/4 | Thermoplastic Rubber | 220 | 6-1/2" (165) | 4-3/32" (104) | Plain Bore | CS-05TPO-125-SW-TP01 |
| 5" (125) | 1-1/4 | Polyurethane TPU | 220 | 6-1/2" (165) | 4-3/32" (104) | Precision Ball | CS-05PYP-125-SW-TP01 |



TOP PLATE FITTING

Swivel Top Plate Pattern

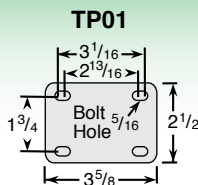

CHROME STEEL (CS)

SWIVEL TOP PLATE MODELS

FREE SWIVEL • TOTAL LOCK • DIRECTION LOCK

SWIVEL TOP PLATE TOTAL LOCK MODELS (WHEEL AND SWIVEL)

| Wheel Diameter inches (mm) | Tread Width (inches) | Wheel Description | Capacity (lbs) | Load Height inches (mm) | Swivel Radius inches (mm) | Wheel Bearing | Model Number |
|----------------------------|----------------------|----------------------|----------------|-------------------------|---------------------------|----------------|----------------------|
| 4" (100) | 1-1/4 | Neoprene Rubber | 190 | 5-1/2" (140) | 5-3/8" (136) | Precision Ball | CS-04NRP-125-TL-TP01 |
| 4" (100) | 1-1/4 | Thermoplastic Rubber | 190 | 5-1/2" (140) | 5-3/8" (136) | Precision Ball | CS-04TPP-125-TL-TP01 |
| 4" (100) | 1-1/4 | Thermoplastic Rubber | 190 | 5-1/2" (140) | 5-3/8" (136) | Plain Bore | CS-04TPO-125-TL-TP01 |
| 4" (100) | 1-1/4 | Polyurethane TPU | 190 | 5-1/2" (140) | 5-3/8" (136) | Precision Ball | CS-04PYP-125-TL-TP01 |
| 5" (125) | 1-1/4 | Neoprene Rubber | 220 | 6-1/2" (165) | 5-3/8" (136) | Precision Ball | CS-05NRP-125-TL-TP01 |
| 5" (125) | 1-1/4 | Thermoplastic Rubber | 220 | 6-1/2" (165) | 5-3/8" (136) | Precision Ball | CS-05TPP-125-TL-TP01 |
| 5" (125) | 1-1/4 | Thermoplastic Rubber | 220 | 6-1/2" (165) | 5-3/8" (136) | Plain Bore | CS-05TPO-125-TL-TP01 |
| 5" (125) | 1-1/4 | Polyurethane TPU | 220 | 6-1/2" (165) | 5-3/8" (136) | Precision Ball | CS-05PYP-125-TL-TP01 |



"Brake" stamped on pedal.

SWIVEL TOP PLATE DIRECTION LOCK MODELS (SWIVEL ONLY)

| Wheel Diameter inches (mm) | Tread Width (inches) | Wheel Description | Capacity (lbs) | Load Height inches (mm) | Swivel Radius inches (mm) | Wheel Bearing | Model Number |
|----------------------------|----------------------|----------------------|----------------|-------------------------|---------------------------|----------------|----------------------|
| 4" (100) | 1-1/4 | Neoprene Rubber | 190 | 5-1/2" (140) | 5-3/8" (136) | Precision Ball | CS-04NRP-125-DL-TP01 |
| 4" (100) | 1-1/4 | Thermoplastic Rubber | 190 | 5-1/2" (140) | 5-3/8" (136) | Precision Ball | CS-04TPP-125-DL-TP01 |
| 4" (100) | 1-1/4 | Thermoplastic Rubber | 190 | 5-1/2" (140) | 5-3/8" (136) | Plain Bore | CS-04TPO-125-DL-TP01 |
| 4" (100) | 1-1/4 | Polyurethane TPU | 190 | 5-1/2" (140) | 5-3/8" (136) | Precision Ball | CS-04PYP-125-DL-TP01 |
| 5" (125) | 1-1/4 | Neoprene Rubber | 220 | 6-1/2" (165) | 5-3/8" (136) | Precision Ball | CS-05NRP-125-DL-TP01 |
| 5" (125) | 1-1/4 | Thermoplastic Rubber | 220 | 6-1/2" (165) | 5-3/8" (136) | Precision Ball | CS-05TPP-125-DL-TP01 |
| 5" (125) | 1-1/4 | Thermoplastic Rubber | 220 | 6-1/2" (165) | 5-3/8" (136) | Plain Bore | CS-05TPO-125-DL-TP01 |
| 5" (125) | 1-1/4 | Polyurethane TPU | 220 | 6-1/2" (165) | 5-3/8" (136) | Precision Ball | CS-05PYP-125-DL-TP01 |



"Steer" stamped on pedal.

TOP PLATE FITTING

Swivel Top Plate Pattern

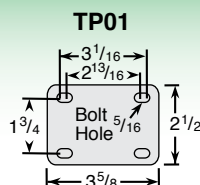

CHROME STEEL (CS)

HOLLOW KINGPIN MODELS
FREE SWIVEL • TOTAL LOCK • DIRECTION LOCK



- APPLICATIONS**
- Food Service
 - Case Carts
 - Utility Carts
 - Medical Equipment
 - Institutional Equipment
 - Hospital Carts
 - Pharmaceutical Equipment

- FEATURES**
- Dual Ball Swivel Raceways for added strength
 - Total Lock Brake models lock both swivel and wheel
 - Directional lock models lock swivel only (helps with Steering)
 - Wheels available with Precision ball bearings or spanner bushing
 - Wheels with Precision Bearings have Full Plastic thread guards for added protection
 - Bright Chrome Finish

Chrome Steel casters that look and meet the European standards.

HOLLOW KINGPIN MODELS

| Wheel Diameter inches (mm) | Tread Width (inches) | Wheel Description | Capacity (Lbs) | Load Height inches (mm) | Swivel Radius inches (mm) | Wheel Bearing | Model Number |
|----------------------------|----------------------|----------------------|----------------|-------------------------|---------------------------|----------------|----------------------|
| 4" (100) | 1-1/4 | Neoprene Rubber | 190 | 5-5/16" (135) | 3-15/32" (88) | Precision Ball | CS-04NRP-125-SW-HKU1 |
| 4" (100) | 1-1/4 | Thermoplastic Rubber | 190 | 5-5/16" (135) | 3-15/32" (88) | Precision Ball | CS-04TPP-125-SW-HKU1 |
| 4" (100) | 1-1/4 | Thermoplastic Rubber | 190 | 5-5/16" (135) | 3-15/32" (88) | Plain Bore | CS-04TPO-125-SW-HKU1 |
| 4" (100) | 1-1/4 | Polyurethane TPU | 190 | 5-5/16" (135) | 3-15/32" (88) | Precision Ball | CS-04PYP-125-SW-HKU1 |
| 5" (125) | 1-1/4 | Neoprene Rubber | 220 | 6-5/16" (160) | 4-3/32" (104) | Precision Ball | CS-05NRP-125-SW-HKU1 |
| 5" (125) | 1-1/4 | Thermoplastic Rubber | 220 | 6-5/16" (160) | 4-3/32" (104) | Precision Ball | CS-05TPP-125-SW-HKU1 |
| 5" (125) | 1-1/4 | Thermoplastic Rubber | 220 | 6-5/16" (160) | 4-3/32" (104) | Plain Bore | CS-05TPO-125-SW-HKU1 |
| 5" (125) | 1-1/4 | Polyurethane TPU | 220 | 6-5/16" (160) | 4-3/32" (104) | Precision Ball | CS-05PYP-125-SW-HKU1 |



HOLLOW KINGPIN

Caster is provided unassembled to make it easy to add your choice of fitting. If you would like these assembled change HKU1 to HK01. 1/2 I.D.



CHROME STEEL (CS)

HOLLOW KINGPIN MODELS

FREE SWIVEL • TOTAL LOCK • DIRECTION LOCK

HOLLOW KINGPIN TOTAL LOCK MODELS (WHEEL AND SWIVEL)

| Wheel Diameter inches (mm) | Tread Width (inches) | Wheel Description | Capacity (Lbs) | Load Height inches (mm) | Swivel Radius inches (mm) | Wheel Bearing | Model Number |
|----------------------------|----------------------|----------------------|----------------|-------------------------|---------------------------|----------------|----------------------|
| 4" (100) | 1-1/4 | Neoprene Rubber | 190 | 5-5/16" (135) | 5-3/8" (136) | Precision Ball | CS-04NRP-125-TL-HKU1 |
| 4" (100) | 1-1/4 | Thermoplastic Rubber | 190 | 5-5/16" (135) | 5-3/8" (136) | Precision Ball | CS-04TPP-125-TL-HKU1 |
| 4" (100) | 1-1/4 | Thermoplastic Rubber | 190 | 5-5/16" (135) | 5-3/8" (136) | Plain Bore | CS-04TPO-125-TL-HKU1 |
| 4" (100) | 1-1/4 | Polyurethane TPU | 190 | 5-5/16" (135) | 5-3/8" (136) | Precision Ball | CS-04PYP-125-TL-HKU1 |
| 5" (125) | 1-1/4 | Neoprene Rubber | 220 | 6-5/16" (160) | 5-3/8" (136) | Precision Ball | CS-05NRP-125-TL-HKU1 |
| 5" (125) | 1-1/4 | Thermoplastic Rubber | 220 | 6-5/16" (160) | 5-3/8" (136) | Precision Ball | CS-05TPP-125-TL-HKU1 |
| 5" (125) | 1-1/4 | Thermoplastic Rubber | 220 | 6-5/16" (160) | 5-3/8" (136) | Plain Bore | CS-05TPO-125-TL-HKU1 |
| 5" (125) | 1-1/4 | Polyurethane TPU | 220 | 6-5/16" (160) | 5-3/8" (136) | Precision Ball | CS-05PYP-125-TL-HKU1 |



"Brake" stamped on pedal.

HOLLOW KINGPIN DIRECTION LOCK MODELS (SWIVEL ONLY)

| Wheel Diameter inches (mm) | Tread Width (inches) | Wheel Description | Capacity (Lbs) | Load Height inches (mm) | Swivel Radius inches (mm) | Wheel Bearing | Model Number |
|----------------------------|----------------------|----------------------|----------------|-------------------------|---------------------------|----------------|----------------------|
| 4" (100) | 1-1/4 | Neoprene Rubber | 190 | 5-5/16" (135) | 5-3/8" (136) | Precision Ball | CS-04NRP-125-DL-HKU1 |
| 4" (100) | 1-1/4 | Thermoplastic Rubber | 190 | 5-5/16" (135) | 5-3/8" (136) | Precision Ball | CS-04TPP-125-DL-HKU1 |
| 4" (100) | 1-1/4 | Thermoplastic Rubber | 190 | 5-5/16" (135) | 5-3/8" (136) | Plain Bore | CS-04TPO-125-DL-HKU1 |
| 4" (100) | 1-1/4 | Polyurethane TPU | 190 | 5-5/16" (135) | 5-3/8" (136) | Precision Ball | CS-04PYP-125-DL-HKU1 |
| 5" (125) | 1-1/4 | Neoprene Rubber | 220 | 6-5/16" (160) | 5-3/8" (136) | Precision Ball | CS-05NRP-125-DL-HKU1 |
| 5" (125) | 1-1/4 | Thermoplastic Rubber | 220 | 6-5/16" (160) | 5-3/8" (136) | Precision Ball | CS-05TPP-125-DL-HKU1 |
| 5" (125) | 1-1/4 | Thermoplastic Rubber | 220 | 6-5/16" (160) | 5-3/8" (136) | Plain Bore | CS-05TPO-125-DL-HKU1 |
| 5" (125) | 1-1/4 | Polyurethane TPU | 220 | 6-5/16" (160) | 5-3/8" (136) | Precision Ball | CS-05PYP-125-DL-HKU1 |



"Steer" stamped on pedal.

HOLLOW KINGPIN

Caster is provided unassembled to make it easy to add your choice of fitting. If you would like these assembled change HKU1 to HK01.
1/2 I.D.

CHROME STEEL (CS)

THREADED STEM MODELS

FREE SWIVEL • TOTAL LOCK • DIRECTION LOCK



- APPLICATIONS**
- Food Service
 - Case Carts
 - Utility Carts
 - Medical Equipment
 - Institutional Equipment
 - Hospital Carts
 - Pharmaceutical Equipment

- FEATURES**
- Dual Ball Swivel Raceways for added strength
 - Total Lock Brake models lock both swivel and wheel
 - Directional lock models lock swivel only (helps with Steering)
 - Wheels available with Precision ball bearings or spanner bushing
 - Wheels with Precision Bearings have Full Plastic thread guards for added protection
 - Bright Chrome Finish

Chrome Steel casters that look and meet the European standards.

THREADED STEM MODELS

| Wheel Diameter inches (mm) | Tread Width (inches) | Wheel Description | Capacity (Lbs) | Load Height inches (mm) | Swivel Radius inches (mm) | Wheel Bearing | Model Number |
|----------------------------|----------------------|----------------------|----------------|-------------------------|---------------------------|----------------|-----------------------|
| 4" (100) | 1-1/4 | Neoprene Rubber | 190 | 5-5/16" (135) | 3-15/32" (88) | Precision Ball | CS-04NRP-125-SW-_____ |
| 4" (100) | 1-1/4 | Thermoplastic Rubber | 190 | 5-5/16" (135) | 3-15/32" (88) | Precision Ball | CS-04TPP-125-SW-_____ |
| 4" (100) | 1-1/4 | Thermoplastic Rubber | 190 | 5-5/16" (135) | 3-15/32" (88) | Plain Bore | CS-04TPO-125-SW-_____ |
| 4" (100) | 1-1/4 | Polyurethane TPU | 190 | 5-5/16" (135) | 3-15/32" (88) | Precision Ball | CS-04PYP-125-SW-_____ |
| 5" (125) | 1-1/4 | Neoprene Rubber | 220 | 6-5/16" (160) | 4-3/32" (104) | Precision Ball | CS-05NRP-125-SW-_____ |
| 5" (125) | 1-1/4 | Thermoplastic Rubber | 220 | 6-5/16" (160) | 4-3/32" (104) | Precision Ball | CS-05TPP-125-SW-_____ |
| 5" (125) | 1-1/4 | Thermoplastic Rubber | 220 | 6-5/16" (160) | 4-3/32" (104) | Plain Bore | CS-05TPO-125-SW-_____ |
| 5" (125) | 1-1/4 | Polyurethane TPU | 220 | 6-5/16" (160) | 4-3/32" (104) | Precision Ball | CS-05PYP-125-SW-_____ |



Specify Threaded Stem (TS) code, see fittings below for dimensions.

THREADED STEM FITTINGS

Easy to install stem. See fittings page for more options.

TS02



TS03



CHROME STEEL (CS)

THREADED STEM MODELS

FREE SWIVEL • TOTAL LOCK • DIRECTION LOCK

THREADED STEM TOTAL LOCK MODELS (WHEEL AND SWIVEL)

| Wheel Diameter inches (mm) | Tread Width (inches) | Wheel Description | Capacity (Lbs) | Load Height inches (mm) | Swivel Radius inches (mm) | Wheel Bearing | Model Number |
|----------------------------|----------------------|----------------------|----------------|-------------------------|---------------------------|----------------|---------------------|
| 4" (100) | 1-1/4 | Neoprene Rubber | 190 | 5-5/16" (135) | 5-3/8" (136) | Precision Ball | CS-04NRP-125-TL-___ |
| 4" (100) | 1-1/4 | Thermoplastic Rubber | 190 | 5-5/16" (135) | 5-3/8" (136) | Precision Ball | CS-04TPP-125-TL-___ |
| 4" (100) | 1-1/4 | Thermoplastic Rubber | 190 | 5-5/16" (135) | 5-3/8" (136) | Plain Bore | CS-04TPO-125-TL-___ |
| 4" (100) | 1-1/4 | Polyurethane TPU | 190 | 5-5/16" (135) | 5-3/8" (136) | Precision Ball | CS-04PYP-125-TL-___ |
| 5" (125) | 1-1/4 | Neoprene Rubber | 220 | 6-5/16" (160) | 5-3/8" (136) | Precision Ball | CS-05NRP-125-TL-___ |
| 5" (125) | 1-1/4 | Thermoplastic Rubber | 220 | 6-5/16" (160) | 5-3/8" (136) | Precision Ball | CS-05TPP-125-TL-___ |
| 5" (125) | 1-1/4 | Thermoplastic Rubber | 220 | 6-5/16" (160) | 5-3/8" (136) | Plain Bore | CS-05TPO-125-TL-___ |
| 5" (125) | 1-1/4 | Polyurethane TPU | 220 | 6-5/16" (160) | 5-3/8" (136) | Precision Ball | CS-05PYP-125-TL-___ |



"Brake" stamped on pedal.

THREADED STEM DIRECTION LOCK MODELS (SWIVEL ONLY)

| Wheel Diameter inches (mm) | Tread Width (inches) | Wheel Description | Capacity (Lbs) | Load Height inches (mm) | Swivel Radius inches (mm) | Wheel Bearing | Model Number |
|----------------------------|----------------------|----------------------|----------------|-------------------------|---------------------------|----------------|---------------------|
| 4" (100) | 1-1/4 | Neoprene Rubber | 190 | 5-5/16" (135) | 5-3/8" (136) | Precision Ball | CS-04NRP-125-DL-___ |
| 4" (100) | 1-1/4 | Thermoplastic Rubber | 190 | 5-5/16" (135) | 5-3/8" (136) | Precision Ball | CS-04TPP-125-DL-___ |
| 4" (100) | 1-1/4 | Thermoplastic Rubber | 190 | 5-5/16" (135) | 5-3/8" (136) | Plain Bore | CS-04TPO-125-DL-___ |
| 4" (100) | 1-1/4 | Polyurethane TPU | 190 | 5-5/16" (135) | 5-3/8" (136) | Precision Ball | CS-04PYP-125-DL-___ |
| 5" (125) | 1-1/4 | Neoprene Rubber | 220 | 6-5/16" (160) | 5-3/8" (136) | Precision Ball | CS-05NRP-125-DL-___ |
| 5" (125) | 1-1/4 | Thermoplastic Rubber | 220 | 6-5/16" (160) | 5-3/8" (136) | Precision Ball | CS-05TPP-125-DL-___ |
| 5" (125) | 1-1/4 | Thermoplastic Rubber | 220 | 6-5/16" (160) | 5-3/8" (136) | Plain Bore | CS-05TPO-125-DL-___ |
| 5" (125) | 1-1/4 | Polyurethane TPU | 220 | 6-5/16" (160) | 5-3/8" (136) | Precision Ball | CS-05PYP-125-DL-___ |



"Steer" stamped on pedal.

Specify Threaded Stem (TS) code, see fittings below for dimensions.

THREADED STEM FITTINGS

Easy to install stem. See fittings page for more options.

TS02



TS03



CHROME STEEL (CS)

GRIP RING STEM MODELS

FREE SWIVEL • TOTAL LOCK • DIRECTION LOCK



- APPLICATIONS**
- Food Service
 - Case Carts
 - Utility Carts
 - Medical Equipment
 - Institutional Equipment
 - Hospital Carts
 - Pharmaceutical Equipment

- FEATURES**
- Dual Ball Swivel Raceways for added strength
 - Total Lock Brake models lock both swivel and wheel
 - Directional lock models lock swivel only (helps with Steering)
 - Wheels available with Precision ball bearings or spanner bushing
 - Wheels with Precision Bearings have Full Plastic thread guards for added protection
 - Bright Chrome Finish

Chrome Steel casters that look and meet the European standards.

GRIP RING STEM MODELS

| Wheel Diameter inches (mm) | Tread Width (inches) | Wheel Description | Capacity (Lbs) | Load Height inches (mm) | Swivel Radius inches (mm) | Wheel Bearing | Model Number |
|----------------------------|----------------------|----------------------|----------------|-------------------------|---------------------------|----------------|------------------|
| 4" (100) | 1-1/4 | Neoprene Rubber | 190 | 5-5/16" (135) | 3-15/32" (88) | Precision Ball | CS-04NRP-125-SW- |
| 4" (100) | 1-1/4 | Thermoplastic Rubber | 190 | 5-5/16" (135) | 3-15/32" (88) | Precision Ball | CS-04TPP-125-SW- |
| 4" (100) | 1-1/4 | Thermoplastic Rubber | 190 | 5-5/16" (135) | 3-15/32" (88) | Plain Bore | CS-04TPO-125-SW- |
| 4" (100) | 1-1/4 | Polyurethane TPU | 190 | 5-5/16" (135) | 3-15/32" (88) | Precision Ball | CS-04PYP-125-SW- |
| 5" (125) | 1-1/4 | Neoprene Rubber | 220 | 6-5/16" (160) | 4-3/32" (104) | Precision Ball | CS-05NRP-125-SW- |
| 5" (125) | 1-1/4 | Thermoplastic Rubber | 220 | 6-5/16" (160) | 4-3/32" (104) | Precision Ball | CS-05TPP-125-SW- |
| 5" (125) | 1-1/4 | Thermoplastic Rubber | 220 | 6-5/16" (160) | 4-3/32" (104) | Plain Bore | CS-05TPO-125-SW- |
| 5" (125) | 1-1/4 | Polyurethane TPU | 220 | 6-5/16" (160) | 4-3/32" (104) | Precision Ball | CS-05PYP-125-SW- |



Specify Grip Ring Stem (GR) code, see fittings below for dimensions.

GRIP RING STEM FITTINGS

Easy to install grip rings snap into place. See fittings page for more options.

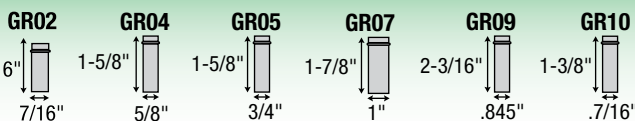

CHROME STEEL (CS)

GRIP RING STEM MODELS

FREE SWIVEL • TOTAL LOCK • DIRECTION LOCK

GRIP RING TOTAL LOCK MODELS (WHEEL AND SWIVEL)

| Wheel Diameter inches (mm) | Tread Width (inches) | Wheel Description | Capacity (Lbs) | Load Height inches (mm) | Swivel Radius inches (mm) | Wheel Bearing | Model Number |
|----------------------------|----------------------|----------------------|----------------|-------------------------|---------------------------|----------------|---------------------|
| 4" (100) | 1-1/4 | Neoprene Rubber | 190 | 5-5/16" (135) | 5-3/8" (136) | Precision Ball | CS-04NRP-125-TL-___ |
| 4" (100) | 1-1/4 | Thermoplastic Rubber | 190 | 5-5/16" (135) | 5-3/8" (136) | Precision Ball | CS-04TPP-125-TL-___ |
| 4" (100) | 1-1/4 | Thermoplastic Rubber | 190 | 5-5/16" (135) | 5-3/8" (136) | Plain Bore | CS-04TPO-125-TL-___ |
| 4" (100) | 1-1/4 | Polyurethane TPU | 190 | 5-5/16" (135) | 5-3/8" (136) | Precision Ball | CS-04PYP-125-TL-___ |
| 5" (125) | 1-1/4 | Neoprene Rubber | 220 | 6-5/16" (160) | 5-3/8" (136) | Precision Ball | CS-05NRP-125-TL-___ |
| 5" (125) | 1-1/4 | Thermoplastic Rubber | 220 | 6-5/16" (160) | 5-3/8" (136) | Precision Ball | CS-05TPP-125-TL-___ |
| 5" (125) | 1-1/4 | Thermoplastic Rubber | 220 | 6-5/16" (160) | 5-3/8" (136) | Plain Bore | CS-05TPO-125-TL-___ |
| 5" (125) | 1-1/4 | Polyurethane TPU | 220 | 6-5/16" (160) | 5-3/8" (136) | Precision Ball | CS-05PYP-125-TL-___ |



"Brake" stamped on pedal.

GRIP RING DIRECTION LOCK MODELS (SWIVEL ONLY)

| Wheel Diameter inches (mm) | Tread Width (inches) | Wheel Description | Capacity (Lbs) | Load Height inches (mm) | Swivel Radius inches (mm) | Wheel Bearing | Model Number |
|----------------------------|----------------------|----------------------|----------------|-------------------------|---------------------------|----------------|---------------------|
| 4" (100) | 1-1/4 | Neoprene Rubber | 190 | 5-5/16" (135) | 5-3/8" (136) | Precision Ball | CS-04NRP-125-DL-___ |
| 4" (100) | 1-1/4 | Thermoplastic Rubber | 190 | 5-5/16" (135) | 5-3/8" (136) | Precision Ball | CS-04TPP-125-DL-___ |
| 4" (100) | 1-1/4 | Thermoplastic Rubber | 190 | 5-5/16" (135) | 5-3/8" (136) | Plain Bore | CS-04TPO-125-DL-___ |
| 4" (100) | 1-1/4 | Polyurethane TPU | 190 | 5-5/16" (135) | 5-3/8" (136) | Precision Ball | CS-04PYP-125-DL-___ |
| 5" (125) | 1-1/4 | Neoprene Rubber | 220 | 6-5/16" (160) | 5-3/8" (136) | Precision Ball | CS-05NRP-125-DL-___ |
| 5" (125) | 1-1/4 | Thermoplastic Rubber | 220 | 6-5/16" (160) | 5-3/8" (136) | Precision Ball | CS-05TPP-125-DL-___ |
| 5" (125) | 1-1/4 | Thermoplastic Rubber | 220 | 6-5/16" (160) | 5-3/8" (136) | Plain Bore | CS-05TPO-125-DL-___ |
| 5" (125) | 1-1/4 | Polyurethane TPU | 220 | 6-5/16" (160) | 5-3/8" (136) | Precision Ball | CS-05PYP-125-DL-___ |



"Steer" stamped on pedal.

Specify Grip Ring Stem (GR) code, see fittings below for dimensions.

GRIP RING STEM FITTINGS

Easy to install grip rings snap into place. See fittings page for more options.

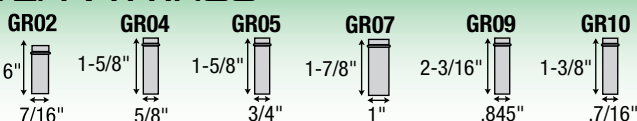

CHROME STEEL (CS)

ROUND/SQUARE STEM MODELS
FREE SWIVEL • TOTAL LOCK • DIRECTION LOCK



- APPLICATIONS**
- Food Service
 - Case Carts
 - Utility Carts
 - Medical Equipment
 - Institutional Equipment
 - Hospital Carts
 - Pharmaceutical Equipment

- FEATURES**
- Dual Ball Swivel Raceways for added strength
 - Total Lock Brake models lock both swivel and wheel
 - Directional lock models lock swivel only (helps with Steering)
 - Wheels available with Precision ball bearings or spanner bushing
 - Wheels with Precision Bearings have Full Plastic thread guards for added protection
 - Bright Chrome Finish

Chrome Steel casters that look and meet the European standards.

ROUND/SQUARE STEM MODELS

| Wheel Diameter inches (mm) | Tread Width (inches) | Wheel Description | Capacity (Lbs) | Load Height inches (mm) | Swivel Radius inches (mm) | Wheel Bearing | Model Number |
|----------------------------|----------------------|----------------------|----------------|-------------------------|---------------------------|----------------|------------------|
| 4" (100) | 1-1/4 | Neoprene Rubber | 190 | 5-5/16" (135) | 3-15/32" (88) | Precision Ball | CS-04NRP-125-SW- |
| 4" (100) | 1-1/4 | Thermoplastic Rubber | 190 | 5-5/16" (135) | 3-15/32" (88) | Precision Ball | CS-04TPP-125-SW- |
| 4" (100) | 1-1/4 | Thermoplastic Rubber | 190 | 5-5/16" (135) | 3-15/32" (88) | Plain Bore | CS-04TPO-125-SW- |
| 4" (100) | 1-1/4 | Polyurethane TPU | 190 | 5-5/16" (135) | 3-15/32" (88) | Precision Ball | CS-04PYP-125-SW- |
| 5" (125) | 1-1/4 | Neoprene Rubber | 220 | 6-5/16" (160) | 4-3/32" (104) | Precision Ball | CS-05NRP-125-SW- |
| 5" (125) | 1-1/4 | Thermoplastic Rubber | 220 | 6-5/16" (160) | 4-3/32" (104) | Precision Ball | CS-05TPP-125-SW- |
| 5" (125) | 1-1/4 | Thermoplastic Rubber | 220 | 6-5/16" (160) | 4-3/32" (104) | Plain Bore | CS-05TPO-125-SW- |
| 5" (125) | 1-1/4 | Polyurethane TPU | 220 | 6-5/16" (160) | 4-3/32" (104) | Precision Ball | CS-05PYP-125-SW- |



Specify Round Stem (RS) code, or Square Stem (SQ) code. See fittings below for dimensions.

ROUND STEM FITTINGS

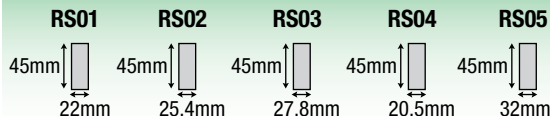

SQUARE STEM FITTINGS



See fittings page for more options.



CHROME STEEL (CS)

ROUND/SQUARE TOTAL LOCK MODELS (WHEEL AND SWIVEL)

| Wheel Diameter inches (mm) | Tread Width (inches) | Wheel Description | Capacity (Lbs) | Load Height inches (mm) | Swivel Radius inches (mm) | Wheel Bearing | Model Number |
|----------------------------|----------------------|----------------------|----------------|-------------------------|---------------------------|----------------|---------------------|
| 4" (100) | 1-1/4 | Neoprene Rubber | 190 | 5-5/16" (135) | 5-3/8" (136) | Precision Ball | CS-04NRP-125-TL-___ |
| 4" (100) | 1-1/4 | Thermoplastic Rubber | 190 | 5-5/16" (135) | 5-3/8" (136) | Precision Ball | CS-04TPP-125-TL-___ |
| 4" (100) | 1-1/4 | Thermoplastic Rubber | 190 | 5-5/16" (135) | 5-3/8" (136) | Plain Bore | CS-04TPO-125-TL-___ |
| 4" (100) | 1-1/4 | Polyurethane TPU | 190 | 5-5/16" (135) | 5-3/8" (136) | Precision Ball | CS-04PYP-125-TL-___ |
| 5" (125) | 1-1/4 | Neoprene Rubber | 220 | 6-5/16" (160) | 5-3/8" (136) | Precision Ball | CS-05NRP-125-TL-___ |
| 5" (125) | 1-1/4 | Thermoplastic Rubber | 220 | 6-5/16" (160) | 5-3/8" (136) | Precision Ball | CS-05TPP-125-TL-___ |
| 5" (125) | 1-1/4 | Thermoplastic Rubber | 220 | 6-5/16" (160) | 5-3/8" (136) | Plain Bore | CS-05TPO-125-TL-___ |
| 5" (125) | 1-1/4 | Polyurethane TPU | 220 | 6-5/16" (160) | 5-3/8" (136) | Precision Ball | CS-05PYP-125-TL-___ |



"Brake" stamped on pedal.

ROUND/SQUARE DIRECTION LOCK MODELS (SWIVEL ONLY)

| Wheel Diameter inches (mm) | Tread Width (inches) | Wheel Description | Capacity (Lbs) | Load Height inches (mm) | Swivel Radius inches (mm) | Wheel Bearing | Model Number |
|----------------------------|----------------------|----------------------|----------------|-------------------------|---------------------------|----------------|---------------------|
| 4" (100) | 1-1/4 | Neoprene Rubber | 190 | 5-5/16" (135) | 5-3/8" (136) | Precision Ball | CS-04NRP-125-DL-___ |
| 4" (100) | 1-1/4 | Thermoplastic Rubber | 190 | 5-5/16" (135) | 5-3/8" (136) | Precision Ball | CS-04TPP-125-DL-___ |
| 4" (100) | 1-1/4 | Thermoplastic Rubber | 190 | 5-5/16" (135) | 5-3/8" (136) | Plain Bore | CS-04TPO-125-DL-___ |
| 4" (100) | 1-1/4 | Polyurethane TPU | 190 | 5-5/16" (135) | 5-3/8" (136) | Precision Ball | CS-04PYP-125-DL-___ |
| 5" (125) | 1-1/4 | Neoprene Rubber | 220 | 6-5/16" (160) | 5-3/8" (136) | Precision Ball | CS-05NRP-125-DL-___ |
| 5" (125) | 1-1/4 | Thermoplastic Rubber | 220 | 6-5/16" (160) | 5-3/8" (136) | Precision Ball | CS-05TPP-125-DL-___ |
| 5" (125) | 1-1/4 | Thermoplastic Rubber | 220 | 6-5/16" (160) | 5-3/8" (136) | Plain Bore | CS-05TPO-125-DL-___ |
| 5" (125) | 1-1/4 | Polyurethane TPU | 220 | 6-5/16" (160) | 5-3/8" (136) | Precision Ball | CS-05PYP-125-DL-___ |



"Steer" stamped on pedal.

Specify Round Stem (RS) code, or Square Stem (SQ) code. See fittings below for dimensions.

ROUND STEM FITTINGS

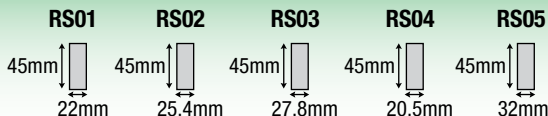

See fittings page for more options.

SQUARE STEM FITTINGS



STAINLESS STEEL (SS)

TOP PLATE MODELS

FREE SWIVEL • TOTAL LOCK • DIRECTION LOCK
1-1/4 TREAD WIDTH



- APPLICATIONS**
- Food Service
 - Case Carts
 - Utility Carts
 - Medical Equipment
 - Institutional Equipment
 - Laboratory Equipment
 - Animal Cages
 - Pharmaceutical Equipment

- FEATURES**
- 304 Stainless Steel, Polished
 - Dual Ball Swivel Raceways for added strength
 - Total Lock Brake models lock both swivel and wheel
 - Directional lock models lock swivel only (helps with Steering)
 - Precision ball bearings in wheels for easier rollability
 - Wheels have full plastic thread guards for added protection
 - TPP and AMP wheels are crowned for easy rolling and turning

Our SS series design is constructed of stainless steel. This design gives you the quality necessary for most medical and pharmaceutical applications at an affordable price.

SWIVEL TOP PLATE MODELS

| Wheel Diameter (Inches) | Tread Width (Inches) | Wheel Description | Capacity (Lbs) | Load Height Inches (mm) | Swivel Radius Inches (mm) | Wheel Bearing | Model Number |
|-------------------------|----------------------|----------------------|----------------|-------------------------|---------------------------|----------------|---------------------|
| 3 | 1-1/4 | Conductive Rubber | 165 | 4-7/16" (113) | 2-29/32" (74) | Annular Ball | SS-03CRB-125-SW-___ |
| 3 | 1-1/4 | Thermoplastic Rubber | 165 | 4-7/16" (113) | 2-29/32" (74) | Precision Ball | SS-03TPP-125-SW-___ |
| 3 | 1-1/4 | Anti-Microbial TPR | 165 | 4-7/16" (113) | 2-29/32" (74) | Precision Ball | SS-03AMP-125-SW-___ |
| 3 | 1-1/4 | Polyurethane TPU | 165 | 4-7/16" (113) | 2-29/32" (74) | Precision Ball | SS-03PYP-125-SW-___ |
| 4 | 1-1/4 | Conductive Rubber | 190 | 5-7/16" (138) | 3-37/64" (91) | Annular Ball | SS-04CRB-125-SW-___ |
| 4 | 1-1/4 | Thermoplastic Rubber | 190 | 5-7/16" (138) | 3-37/64" (91) | Precision Ball | SS-04TPP-125-SW-___ |
| 4 | 1-1/4 | Anti-Microbial TPR | 190 | 5-7/16" (138) | 3-37/64" (91) | Precision Ball | SS-04AMP-125-SW-___ |
| 4 | 1-1/4 | Polyurethane TPU | 190 | 5-7/16" (138) | 3-37/64" (91) | Precision Ball | SS-04PYP-125-SW-___ |
| 5 | 1-1/4 | Conductive Rubber | 220 | 6-7/16" (163) | 4-7/32" (108) | Annular Ball | SS-05CRB-125-SW-___ |
| 5 | 1-1/4 | Thermoplastic Rubber | 220 | 6-7/16" (163) | 4-7/32" (108) | Precision Ball | SS-05TPP-125-SW-___ |
| 5 | 1-1/4 | Anti-Microbial TPR | 220 | 6-7/16" (163) | 4-7/32" (108) | Precision Ball | SS-05AMP-125-SW-___ |
| 5 | 1-1/4 | Polyurethane TPU | 220 | 6-7/16" (163) | 4-7/32" (108) | Precision Ball | SS-05PYP-125-SW-___ |
| 6 | 1-1/4 | Conductive Rubber | 240 | 7-13/32" (188) | 4-39/64 (117) | Annular Ball | SS-06CRB-125-SW-___ |
| 6 | 1-1/4 | Thermoplastic Rubber | 240 | 7-13/32" (188) | 4-39/64 (117) | Precision Ball | SS-06TPP-125-SW-___ |
| 6 | 1-1/4 | Anti-Microbial TPR | 240 | 7-13/32" (188) | 4-39/64 (117) | Precision Ball | SS-06AMP-125-SW-___ |
| 6 | 1-1/4 | Polyurethane TPU | 240 | 7-13/32" (188) | 4-39/64 (117) | Precision Ball | SS-06PYP-125-SW-___ |



Rigid models available change "SW to "RG"

Specify Top Plate (TP___) code, see fittings at left for dimensions.

TOP PLATE FITTING

Swivel Top Plate Pattern

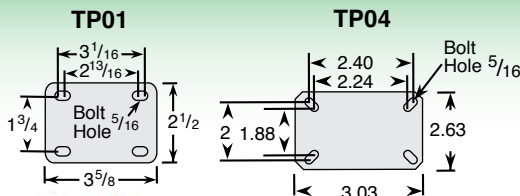

Anti-Microbial wheels have light green tread.



Stainless wheel bearings available. Change Bearing Code to "X" (Example : SS-03CRX-125-SW-___)



STAINLESS STEEL (SS)

SWIVEL TOP PLATE TOTAL LOCK MODELS (LOCKS WHEEL AND SWIVEL)

| Wheel Diameter (Inches) | Tread Width (Inches) | Wheel Description | Capacity (Lbs) | Load Height Inches (mm) | Swivel Radius Inches (mm) | Wheel Bearing | Model Number |
|-------------------------|----------------------|----------------------|----------------|-------------------------|---------------------------|----------------|--------------------|
| 3 | 1-1/4 | Conductive Rubber | 165 | 4-7/16" (113) | 4-1/4" (108) | Annular Ball | SS-03CRB-125-TL-__ |
| 3 | 1-1/4 | Thermoplastic Rubber | 165 | 4-7/16" (113) | 4-1/4" (108) | Precision Ball | SS-03TPP-125-TL-__ |
| 3 | 1-1/4 | Anti-Microbial TPR | 165 | 4-7/16" (113) | 4-1/4" (108) | Precision Ball | SS-03AMP-125-TL-__ |
| 3 | 1-1/4 | Polyurethane TPU | 165 | 4-7/16" (113) | 4-1/4" (108) | Precision Ball | SS-03PYP-125-TL-__ |
| 4 | 1-1/4 | Conductive Rubber | 190 | 5-7/16" (138) | 4-35/64" (115) | Annular Ball | SS-04CRB-125-TL-__ |
| 4 | 1-1/4 | Thermoplastic Rubber | 190 | 5-7/16" (138) | 4-35/64" (115) | Precision Ball | SS-04TPP-125-TL-__ |
| 4 | 1-1/4 | Anti-Microbial TPR | 190 | 5-7/16" (138) | 4-35/64" (115) | Precision Ball | SS-04AMP-125-TL-__ |
| 4 | 1-1/4 | Polyurethane TPU | 190 | 5-7/16" (138) | 4-35/64" (115) | Precision Ball | SS-04PYP-125-TL-__ |
| 5 | 1-1/4 | Conductive Rubber | 220 | 6-7/16" (163) | 4-55/64" (123) | Annular Ball | SS-05CRB-125-TL-__ |
| 5 | 1-1/4 | Thermoplastic Rubber | 220 | 6-7/16" (163) | 4-55/64" (123) | Precision Ball | SS-05TPP-125-TL-__ |
| 5 | 1-1/4 | Anti-Microbial TPR | 220 | 6-7/16" (163) | 4-55/64" (123) | Precision Ball | SS-05AMP-125-TL-__ |
| 5 | 1-1/4 | Polyurethane TPU | 220 | 6-7/16" (163) | 4-55/64" (123) | Precision Ball | SS-05PYP-125-TL-__ |
| 6 | 1-1/4 | Conductive Rubber | 240 | 7-13/32" (188) | 4-55/64" (123) | Annular Ball | SS-06CRB-125-TL-__ |
| 6 | 1-1/4 | Thermoplastic Rubber | 240 | 7-13/32" (188) | 4-55/64" (123) | Precision Ball | SS-06TPP-125-TL-__ |
| 6 | 1-1/4 | Anti-Microbial TPR | 240 | 7-13/32" (188) | 4-55/64" (123) | Precision Ball | SS-06AMP-125-TL-__ |
| 6 | 1-1/4 | Polyurethane TPU | 240 | 7-13/32" (188) | 4-55/64" (123) | Precision Ball | SS-06PYP-125-TL-__ |



Total Lock
Change "SW"
to "TL". **Red**
sticker on pedal.

SWIVEL TOP PLATE DIRECTION LOCK MODELS (LOCKS SWIVEL ONLY)

| Wheel Diameter (Inches) | Tread Width (Inches) | Wheel Description | Capacity (Lbs) | Load Height Inches (mm) | Swivel Radius Inches (mm) | Wheel Bearing | Model Number |
|-------------------------|----------------------|----------------------|----------------|-------------------------|---------------------------|----------------|--------------------|
| 3 | 1-1/4 | Conductive Rubber | 165 | 4-7/16" (113) | 4-1/4" (108) | Annular Ball | SS-03CRB-125-DL-__ |
| 3 | 1-1/4 | Thermoplastic Rubber | 165 | 4-7/16" (113) | 4-1/4" (108) | Precision Ball | SS-03TPP-125-DL-__ |
| 3 | 1-1/4 | Anti-Microbial TPR | 165 | 4-7/16" (113) | 4-1/4" (108) | Precision Ball | SS-03AMP-125-DL-__ |
| 3 | 1-1/4 | Polyurethane TPU | 165 | 4-7/16" (113) | 4-1/4" (108) | Precision Ball | SS-03PYP-125-DL-__ |
| 4 | 1-1/4 | Conductive Rubber | 190 | 5-7/16" (138) | 4-35/64" (115) | Annular Ball | SS-04CRB-125-DL-__ |
| 4 | 1-1/4 | Thermoplastic Rubber | 190 | 5-7/16" (138) | 4-35/64" (115) | Precision Ball | SS-04TPP-125-DL-__ |
| 4 | 1-1/4 | Anti-Microbial TPR | 190 | 5-7/16" (138) | 4-35/64" (115) | Precision Ball | SS-04AMP-125-DL-__ |
| 4 | 1-1/4 | Polyurethane TPU | 190 | 5-7/16" (138) | 4-35/64" (115) | Precision Ball | SS-04PYP-125-DL-__ |
| 5 | 1-1/4 | Conductive Rubber | 220 | 6-7/16" (163) | 4-55/64" (123) | Annular Ball | SS-05CRB-125-DL-__ |
| 5 | 1-1/4 | Thermoplastic Rubber | 220 | 6-7/16" (163) | 4-55/64" (123) | Precision Ball | SS-05TPP-125-DL-__ |
| 5 | 1-1/4 | Anti-Microbial TPR | 220 | 6-7/16" (163) | 4-55/64" (123) | Precision Ball | SS-05AMP-125-DL-__ |
| 5 | 1-1/4 | Polyurethane TPU | 220 | 6-7/16" (163) | 4-55/64" (123) | Precision Ball | SS-05PYP-125-DL-__ |
| 6 | 1-1/4 | Conductive Rubber | 240 | 7-13/32" (188) | 4-55/64" (123) | Annular Ball | SS-06CRB-125-DL-__ |
| 6 | 1-1/4 | Thermoplastic Rubber | 240 | 7-13/32" (188) | 4-55/64" (123) | Precision Ball | SS-06TPP-125-DL-__ |
| 6 | 1-1/4 | Anti-Microbial TPR | 240 | 7-13/32" (188) | 4-55/64" (123) | Precision Ball | SS-06AMP-125-DL-__ |
| 6 | 1-1/4 | Polyurethane TPU | 240 | 7-13/32" (188) | 4-55/64" (123) | Precision Ball | SS-06PYP-125-DL-__ |



Direction Lock
Change "SW"
to "DL". **Green**
sticker on pedal.

Specify Top Plate (TP__)
code, see fittings at left
for dimensions.

TOP PLATE FITTING

Swivel Top
Plate Pattern

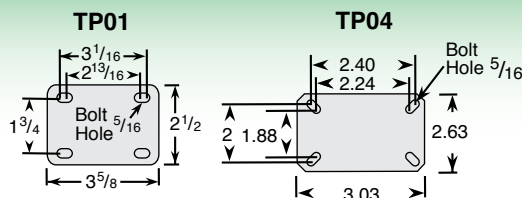

Stainless wheel bearings available. Change Bearing Code
to "X" (Example : SS-03CRX-125-SW-__)



STAINLESS STEEL (SS)

HOLLOW KINGPIN MODELS

FREE SWIVEL • TOTAL LOCK • DIRECTION LOCK
1-1/4 TREAD WIDTH



- APPLICATIONS**
- Food Service
 - Case Carts
 - Utility Carts
 - Medical Equipment
 - Institutional Equipment
 - Laboratory Equipment
 - Animal Cages
 - Pharmaceutical Equipment

- FEATURES**
- 304 Stainless Steel, Polished
 - Dual Ball Swivel Raceways for added strength
 - Total Lock Brake models lock both swivel and wheel
 - Directional lock models lock swivel only (helps with Steering)
 - Precision ball bearings in wheels for easier rollability
 - Wheels have full plastic thread guards for added protection
 - TPP and AMP wheels are crowned for easy rolling and turning

Our SS series design is constructed of stainless steel. This design gives you the quality necessary for most medical and pharmaceutical applications at an affordable price.

HOLLOW KINGPIN MODELS

| Wheel Diameter (Inches) | Tread Width (Inches) | Wheel Description | Capacity (Lbs) | Load Height Inches (mm) | Swivel Radius Inches (mm) | Wheel Bearing | Model Number |
|-------------------------|----------------------|----------------------|----------------|-------------------------|---------------------------|----------------|----------------------|
| 3 | 1-1/4 | Conductive Rubber | 165 | 4-5/16" (109) | 2-29/32" (74) | Annular Ball | SS-03CRB-125-SW-HKU1 |
| 3 | 1-1/4 | Thermoplastic Rubber | 165 | 4-5/16" (109) | 2-29/32" (74) | Precision Ball | SS-03TPP-125-SW-HKU1 |
| 3 | 1-1/4 | Anti-Microbial TPR | 165 | 4-5/16" (109) | 2-29/32" (74) | Precision Ball | SS-03AMP-125-SW-HKU1 |
| 3 | 1-1/4 | Polyurethane TPU | 165 | 4-5/16" (109) | 2-29/32" (74) | Precision Ball | SS-03PYP-125-SW-HKU1 |
| 4 | 1-1/4 | Conductive Rubber | 165 | 5-5/16" (135) | 3-37/64" (91) | Annular Ball | SS-04CRB-125-SW-HKU1 |
| 4 | 1-1/4 | Thermoplastic Rubber | 190 | 5-5/16" (135) | 3-37/64" (91) | Precision Ball | SS-04TPP-125-SW-HKU1 |
| 4 | 1-1/4 | Anti-Microbial TPR | 190 | 5-5/16" (135) | 3-37/64" (91) | Precision Ball | SS-04AMP-125-SW-HKU1 |
| 4 | 1-1/4 | Polyurethane TPU | 190 | 5-5/16" (135) | 3-37/64" (91) | Precision Ball | SS-04PYP-125-SW-HKU1 |
| 5 | 1-1/4 | Conductive Rubber | 220 | 6-5/16" (160) | 4-7/32" (108) | Annular Ball | SS-05CRB-125-SW-HKU1 |
| 5 | 1-1/4 | Thermoplastic Rubber | 220 | 6-5/16" (160) | 4-7/32" (108) | Precision Ball | SS-05TPP-125-SW-HKU1 |
| 5 | 1-1/4 | Anti-Microbial TPR | 220 | 6-5/16" (160) | 4-7/32" (108) | Precision Ball | SS-05AMP-125-SW-HKU1 |
| 5 | 1-1/4 | Polyurethane TPU | 220 | 6-5/16" (160) | 4-7/32" (108) | Precision Ball | SS-05PYP-125-SW-HKU1 |
| 6 | 1-1/4 | Conductive Rubber | 240 | 7-9/32" (185) | 4-39/64 (117) | Annular Ball | SS-06CRB-125-SW-HKU1 |
| 6 | 1-1/4 | Thermoplastic Rubber | 240 | 7-9/32" (185) | 4-39/64 (117) | Precision Ball | SS-06TPP-125-SW-HKU1 |
| 6 | 1-1/4 | Anti-Microbial TPR | 240 | 7-9/32" (185) | 4-39/64 (117) | Precision Ball | SS-06AMP-125-SW-HKU1 |
| 6 | 1-1/4 | Polyurethane TPU | 240 | 7-9/32" (185) | 4-39/64 (117) | Precision Ball | SS-06PYP-125-SW-HKU1 |



HOLLOW KINGPIN

Caster is provided unassembled to make it easy to add your choice of fitting. If you would like these assembled change HKU1 to HKU1.1/2 I.D.

Anti-Microbial wheels have light green tread.



Stainless wheel bearings available. Change Bearing Code to "X" (Example : SS-03CRX-125-SW-___)



STAINLESS STEEL (SS)

HOLLOW KINGPIN TOTAL LOCK MODELS (LOCKS WHEEL AND SWIVEL)

| Wheel Diameter (Inches) | Tread Width (Inches) | Wheel Description | Capacity (Lbs) | Load Height Inches (mm) | Swivel Radius Inches (mm) | Wheel Bearing | Model Number |
|-------------------------|----------------------|----------------------|----------------|-------------------------|---------------------------|----------------|----------------------|
| 3 | 1-1/4 | Conductive Rubber | 165 | 4-5/16" (109) | 4-1/4" (108) | Precision Ball | SS-03CRB-125-TL-HKU1 |
| 3 | 1-1/4 | Thermoplastic Rubber | 165 | 4-5/16" (109) | 4-1/4" (108) | Precision Ball | SS-03TPP-125-TL-HKU1 |
| 3 | 1-1/4 | Anti-Microbial TPR | 165 | 4-5/16" (109) | 4-1/4" (108) | Precision Ball | SS-03AMP-125-TL-HKU1 |
| 3 | 1-1/4 | Polyurethane TPU | 165 | 4-5/16" (109) | 4-1/4" (108) | Precision Ball | SS-03PYP-125-TL-HKU1 |
| 4 | 1-1/4 | Conductive Rubber | 190 | 5-5/16" (135) | 4-35/64" (115) | Precision Ball | SS-04CRB-125-TL-HKU1 |
| 4 | 1-1/4 | Thermoplastic Rubber | 190 | 5-5/16" (135) | 4-35/64" (115) | Precision Ball | SS-04TPP-125-TL-HKU1 |
| 4 | 1-1/4 | Anti-Microbial TPR | 190 | 5-5/16" (135) | 4-35/64" (115) | Precision Ball | SS-04AMP-125-TL-HKU1 |
| 4 | 1-1/4 | Polyurethane TPU | 190 | 5-5/16" (135) | 4-35/64" (115) | Precision Ball | SS-04PYP-125-TL-HKU1 |
| 5 | 1-1/4 | Conductive Rubber | 220 | 6-5/16" (160) | 4-55/64" (123) | Precision Ball | SS-05CRB-125-TL-HKU1 |
| 5 | 1-1/4 | Thermoplastic Rubber | 220 | 6-5/16" (160) | 4-55/64" (123) | Precision Ball | SS-05TPP-125-TL-HKU1 |
| 5 | 1-1/4 | Anti-Microbial TPR | 220 | 6-5/16" (160) | 4-55/64" (123) | Precision Ball | SS-05AMP-125-TL-HKU1 |
| 5 | 1-1/4 | Polyurethane TPU | 220 | 6-5/16" (160) | 4-55/64" (123) | Precision Ball | SS-05PYP-125-TL-HKU1 |
| 6 | 1-1/4 | Conductive Rubber | 240 | 7-9/32" (185) | 4-55/64" (123) | Precision Ball | SS-06CRB-125-TL-HKU1 |
| 6 | 1-1/4 | Thermoplastic Rubber | 240 | 7-9/32" (185) | 4-55/64" (123) | Precision Ball | SS-06TPP-125-TL-HKU1 |
| 6 | 1-1/4 | Anti-Microbial TPR | 240 | 7-9/32" (185) | 4-55/64" (123) | Precision Ball | SS-06AMP-125-TL-HKU1 |
| 6 | 1-1/4 | Polyurethane TPU | 240 | 7-9/32" (185) | 4-55/64" (123) | Precision Ball | SS-06PYP-125-TL-HKU1 |



Total Lock
Change "SW"
to "TL". Red
sticker on pedal.

HOLLOW KINGPIN DIRECTION LOCK MODELS (LOCKS SWIVEL ONLY)

| Wheel Diameter (Inches) | Tread Width (Inches) | Wheel Description | Capacity (Lbs) | Load Height Inches (mm) | Swivel Radius Inches (mm) | Wheel Bearing | Model Number |
|-------------------------|----------------------|----------------------|----------------|-------------------------|---------------------------|----------------|----------------------|
| 3 | 1-1/4 | Conductive Rubber | 165 | 4-5/16" (109) | 4-1/4" (108) | Precision Ball | SS-03CRB-125-DL-HKU1 |
| 3 | 1-1/4 | Thermoplastic Rubber | 165 | 4-5/16" (109) | 4-1/4" (108) | Precision Ball | SS-03TPP-125-DL-HKU1 |
| 3 | 1-1/4 | Anti-Microbial TPR | 165 | 4-5/16" (109) | 4-1/4" (108) | Precision Ball | SS-03AMP-125-DL-HKU1 |
| 3 | 1-1/4 | Polyurethane TPU | 165 | 4-5/16" (109) | 4-1/4" (108) | Precision Ball | SS-03PYP-125-DL-HKU1 |
| 4 | 1-1/4 | Conductive Rubber | 190 | 5-5/16" (135) | 4-35/64" (115) | Precision Ball | SS-04CRB-125-DL-HKU1 |
| 4 | 1-1/4 | Thermoplastic Rubber | 190 | 5-5/16" (135) | 4-35/64" (115) | Precision Ball | SS-04TPP-125-DL-HKU1 |
| 4 | 1-1/4 | Anti-Microbial TPR | 190 | 5-5/16" (135) | 4-35/64" (115) | Precision Ball | SS-04AMP-125-DL-HKU1 |
| 4 | 1-1/4 | Polyurethane TPU | 190 | 5-5/16" (135) | 4-35/64" (115) | Precision Ball | SS-04PYP-125-DL-HKU1 |
| 5 | 1-1/4 | Conductive Rubber | 220 | 6-5/16" (160) | 4-55/64" (123) | Precision Ball | SS-05CRB-125-DL-HKU1 |
| 5 | 1-1/4 | Thermoplastic Rubber | 220 | 6-5/16" (160) | 4-55/64" (123) | Precision Ball | SS-05TPP-125-DL-HKU1 |
| 5 | 1-1/4 | Anti-Microbial TPR | 220 | 6-5/16" (160) | 4-55/64" (123) | Precision Ball | SS-05AMP-125-DL-HKU1 |
| 5 | 1-1/4 | Polyurethane TPU | 220 | 6-5/16" (160) | 4-55/64" (123) | Precision Ball | SS-05PYP-125-DL-HKU1 |
| 6 | 1-1/4 | Conductive Rubber | 240 | 7-9/32" (185) | 4-55/64" (123) | Precision Ball | SS-06CRB-125-DL-HKU1 |
| 6 | 1-1/4 | Thermoplastic Rubber | 240 | 7-9/32" (185) | 4-55/64" (123) | Precision Ball | SS-06TPP-125-DL-HKU1 |
| 6 | 1-1/4 | Anti-Microbial TPR | 240 | 7-9/32" (185) | 4-55/64" (123) | Precision Ball | SS-06AMP-125-DL-HKU1 |
| 6 | 1-1/4 | Polyurethane TPU | 240 | 7-9/32" (185) | 4-55/64" (123) | Precision Ball | SS-06PYP-125-DL-HKU1 |



Direction Lock
Change "SW"
to "DL". Green
sticker on pedal.

HOLLOW KINGPIN

Caster is provided unassembled to make it easy to add your choice of fitting. If you would like these assembled change HKU1 to HKU1.1/2 I.D.

Stainless wheel bearings available. Change Bearing Code to "X" (Example : SS-03CRX-125-SW-___)



STAINLESS STEEL (SS)

THREADED STEM MODELS

FREE SWIVEL • TOTAL LOCK • DIRECTION LOCK
1-1/4 TREAD WIDTH



- APPLICATIONS**
- Food Service
 - Case Carts
 - Utility Carts
 - Medical Equipment
 - Institutional Equipment
 - Laboratory Equipment
 - Animal Cages
 - Pharmaceutical Equipment

- FEATURES**
- 304 Stainless Steel, Polished
 - Dual Ball Swivel Raceways for added strength
 - Total Lock Brake models lock both swivel and wheel
 - Directional lock models lock swivel only (helps with Steering)
 - Precision ball bearings in wheels for easier rollability
 - Wheels have full plastic thread guards for added protection
 - TPP and AMP wheels are crowned for easy rolling and turning

Our SS series design is constructed of stainless steel. This design gives you the quality necessary for most medical and pharmaceutical applications at an affordable price.

THREADED STEM MODELS

| Wheel Diameter (Inches) | Tread Width (Inches) | Wheel Description | Capacity (Lbs) | Load Height Inches (mm) | Swivel Radius Inches (mm) | Wheel Bearing | Model Number |
|-------------------------|----------------------|----------------------|----------------|-------------------------|---------------------------|----------------|----------------------|
| 3 | 1-1/4 | Conductive Rubber | 165 | 4-5/16" (109) | 2-29/32" (74) | Annular Ball | SS-03CRB-125-SW-____ |
| 3 | 1-1/4 | Thermoplastic Rubber | 165 | 4-5/16" (109) | 2-29/32" (74) | Precision Ball | SS-03TPP-125-SW-____ |
| 3 | 1-1/4 | Anti-Microbial TPR | 165 | 4-5/16" (109) | 2-29/32" (74) | Precision Ball | SS-03AMP-125-SW-____ |
| 3 | 1-1/4 | Polyurethane TPU | 165 | 4-5/16" (109) | 2-29/32" (74) | Precision Ball | SS-03PYP-125-SW-____ |
| 4 | 1-1/4 | Conductive Rubber | 165 | 5-5/16" (135) | 3-37/64" (91) | Annular Ball | SS-04CRB-125-SW-____ |
| 4 | 1-1/4 | Thermoplastic Rubber | 190 | 5-5/16" (135) | 3-37/64" (91) | Precision Ball | SS-04TPP-125-SW-____ |
| 4 | 1-1/4 | Anti-Microbial TPR | 190 | 5-5/16" (135) | 3-37/64" (91) | Precision Ball | SS-04AMP-125-SW-____ |
| 4 | 1-1/4 | Polyurethane TPU | 190 | 5-5/16" (135) | 3-37/64" (91) | Precision Ball | SS-04PYP-125-SW-____ |
| 5 | 1-1/4 | Conductive Rubber | 220 | 6-5/16" (160) | 4-7/32" (108) | Annular Ball | SS-05CRB-125-SW-____ |
| 5 | 1-1/4 | Thermoplastic Rubber | 220 | 6-5/16" (160) | 4-7/32" (108) | Precision Ball | SS-05TPP-125-SW-____ |
| 5 | 1-1/4 | Anti-Microbial TPR | 220 | 6-5/16" (160) | 4-7/32" (108) | Precision Ball | SS-05AMP-125-SW-____ |
| 5 | 1-1/4 | Polyurethane TPU | 220 | 6-5/16" (160) | 4-7/32" (108) | Precision Ball | SS-05PYP-125-SW-____ |
| 6 | 1-1/4 | Conductive Rubber | 240 | 7-9/32" (185) | 4-39/64 (117) | Annular Ball | SS-06CRB-125-SW-____ |
| 6 | 1-1/4 | Thermoplastic Rubber | 240 | 7-9/32" (185) | 4-39/64 (117) | Precision Ball | SS-06TPP-125-SW-____ |
| 6 | 1-1/4 | Anti-Microbial TPR | 240 | 7-9/32" (185) | 4-39/64 (117) | Precision Ball | SS-06AMP-125-SW-____ |
| 6 | 1-1/4 | Polyurethane TPU | 240 | 7-9/32" (185) | 4-39/64 (117) | Precision Ball | SS-06PYP-125-SW-____ |



Anti-Microbial wheels have light green tread.



THREADED STEM FITTINGS

See fittings page for more options.

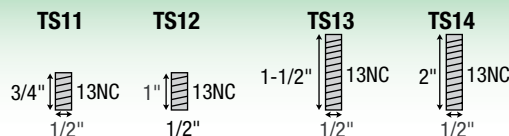

Specify Threaded Stem (TS) code, see fittings at left for dimensions.

Round and square stems available, please consult factory. Stainless wheel bearings available. Change Bearing Code to "X" (Example : SS-03CRX-125-SW-____)



STAINLESS STEEL (SS)

THREADED STEM TOTAL LOCK MODELS (LOCKS WHEEL AND SWIVEL)

| Wheel Diameter (Inches) | Tread Width (Inches) | Wheel Description | Capacity (Lbs) | Load Height Inches (mm) | Swivel Radius Inches (mm) | Wheel Bearing | Model Number |
|-------------------------|----------------------|----------------------|----------------|-------------------------|---------------------------|----------------|----------------------|
| 3 | 1-1/4 | Conductive Rubber | 165 | 4-5/16" (109) | 4-1/4" (108) | Precision Ball | SS-03CRB-125-TL-____ |
| 3 | 1-1/4 | Thermoplastic Rubber | 165 | 4-5/16" (109) | 4-1/4" (108) | Precision Ball | SS-03TPP-125-TL-____ |
| 3 | 1-1/4 | Anti-Microbial TPR | 165 | 4-5/16" (109) | 4-1/4" (108) | Precision Ball | SS-03AMP-125-TL-____ |
| 3 | 1-1/4 | Polyurethane TPU | 165 | 4-5/16" (109) | 4-1/4" (108) | Precision Ball | SS-03PYP-125-TL-____ |
| 4 | 1-1/4 | Conductive Rubber | 190 | 5-5/16" (135) | 4-35/64" (115) | Precision Ball | SS-04CRB-125-TL-____ |
| 4 | 1-1/4 | Thermoplastic Rubber | 190 | 5-5/16" (135) | 4-35/64" (115) | Precision Ball | SS-04TPP-125-TL-____ |
| 4 | 1-1/4 | Anti-Microbial TPR | 190 | 5-5/16" (135) | 4-35/64" (115) | Precision Ball | SS-04AMP-125-TL-____ |
| 4 | 1-1/4 | Polyurethane TPU | 190 | 5-5/16" (135) | 4-35/64" (115) | Precision Ball | SS-04PYP-125-TL-____ |
| 5 | 1-1/4 | Conductive Rubber | 220 | 6-5/16" (160) | 4-55/64" (123) | Precision Ball | SS-05CRB-125-TL-____ |
| 5 | 1-1/4 | Thermoplastic Rubber | 220 | 6-5/16" (160) | 4-55/64" (123) | Precision Ball | SS-05TPP-125-TL-____ |
| 5 | 1-1/4 | Anti-Microbial TPR | 220 | 6-5/16" (160) | 4-55/64" (123) | Precision Ball | SS-05AMP-125-TL-____ |
| 5 | 1-1/4 | Polyurethane TPU | 220 | 6-5/16" (160) | 4-55/64" (123) | Precision Ball | SS-05PYP-125-TL-____ |
| 6 | 1-1/4 | Conductive Rubber | 240 | 7-9/32" (185) | 4-55/64" (123) | Precision Ball | SS-06CRB-125-TL-____ |
| 6 | 1-1/4 | Thermoplastic Rubber | 240 | 7-9/32" (185) | 4-55/64" (123) | Precision Ball | SS-06TPP-125-TL-____ |
| 6 | 1-1/4 | Anti-Microbial TPR | 240 | 7-9/32" (185) | 4-55/64" (123) | Precision Ball | SS-06AMP-125-TL-____ |
| 6 | 1-1/4 | Polyurethane TPU | 240 | 7-9/32" (185) | 4-55/64" (123) | Precision Ball | SS-06PYP-125-TL-____ |



Total Lock
Change "SW"
to "TL". Red
sticker on pedal.

THREADED STEM DIRECTION LOCK MODELS (LOCKS SWIVEL ONLY)

| Wheel Diameter (Inches) | Tread Width (Inches) | Wheel Description | Capacity (Lbs) | Load Height Inches (mm) | Swivel Radius Inches (mm) | Wheel Bearing | Model Number |
|-------------------------|----------------------|----------------------|----------------|-------------------------|---------------------------|----------------|----------------------|
| 3 | 1-1/4 | Conductive Rubber | 165 | 4-5/16" (109) | 4-1/4" (108) | Precision Ball | SS-03CRB-125-DL-____ |
| 3 | 1-1/4 | Thermoplastic Rubber | 165 | 4-5/16" (109) | 4-1/4" (108) | Precision Ball | SS-03TPP-125-DL-____ |
| 3 | 1-1/4 | Anti-Microbial TPR | 165 | 4-5/16" (109) | 4-1/4" (108) | Precision Ball | SS-03AMP-125-DL-____ |
| 3 | 1-1/4 | Polyurethane TPU | 165 | 4-5/16" (109) | 4-1/4" (108) | Precision Ball | SS-03PYP-125-DL-____ |
| 4 | 1-1/4 | Conductive Rubber | 190 | 5-5/16" (135) | 4-35/64" (115) | Precision Ball | SS-04CRB-125-DL-____ |
| 4 | 1-1/4 | Thermoplastic Rubber | 190 | 5-5/16" (135) | 4-35/64" (115) | Precision Ball | SS-04TPP-125-DL-____ |
| 4 | 1-1/4 | Anti-Microbial TPR | 190 | 5-5/16" (135) | 4-35/64" (115) | Precision Ball | SS-04AMP-125-DL-____ |
| 4 | 1-1/4 | Polyurethane TPU | 190 | 5-5/16" (135) | 4-35/64" (115) | Precision Ball | SS-04PYP-125-DL-____ |
| 5 | 1-1/4 | Conductive Rubber | 220 | 6-5/16" (160) | 4-55/64" (123) | Precision Ball | SS-05CRB-125-DL-____ |
| 5 | 1-1/4 | Thermoplastic Rubber | 220 | 6-5/16" (160) | 4-55/64" (123) | Precision Ball | SS-05TPP-125-DL-____ |
| 5 | 1-1/4 | Anti-Microbial TPR | 220 | 6-5/16" (160) | 4-55/64" (123) | Precision Ball | SS-05AMP-125-DL-____ |
| 5 | 1-1/4 | Polyurethane TPU | 220 | 6-5/16" (160) | 4-55/64" (123) | Precision Ball | SS-05PYP-125-DL-____ |
| 6 | 1-1/4 | Conductive Rubber | 240 | 7-9/32" (185) | 4-55/64" (123) | Precision Ball | SS-06CRB-125-DL-____ |
| 6 | 1-1/4 | Thermoplastic Rubber | 240 | 7-9/32" (185) | 4-55/64" (123) | Precision Ball | SS-06TPP-125-DL-____ |
| 6 | 1-1/4 | Anti-Microbial TPR | 240 | 7-9/32" (185) | 4-55/64" (123) | Precision Ball | SS-06AMP-125-DL-____ |
| 6 | 1-1/4 | Polyurethane TPU | 240 | 7-9/32" (185) | 4-55/64" (123) | Precision Ball | SS-06PYP-125-DL-____ |



Direction Lock
Change "SW"
to "DL". Green
sticker on pedal.

THREADED STEM FITTINGS

See fittings page for more options.

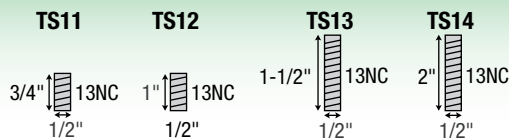

Round and square stems available, please consult factory.
Stainless wheel bearings available. Change Bearing Code to "X" (Example : SS-03CRX-125-SW-____)

Specify Threaded Stem (TS) code, see fittings at left for dimensions.

STAINLESS STEEL (SS)

TOP PLATE MODELS

FREE SWIVEL • TOTAL LOCK
2" TREAD WIDTH



New Total Lock brake design – locks both brake and swivel.

- APPLICATIONS**
- Food Service
 - Case Carts
 - Utility Carts
 - Medical Equipment
 - Institutional Equipment
 - Laboratory Equipment
 - Animal Cages
 - Pharmaceutical Equipment

- FEATURES**
- Fork legs, top plate and yoke base are made of 1/4" thick 304 polished stainless steel for added corrosion protection
 - Total Lock brake models lock both brake and swivel
 - Dual Ball Swivel Raceways for added strength
 - Swivel seals are standard for added protection
 - Stainless axles provided with grease fitting
 - Grease fitting in swivel raceway

Our SS series design is constructed of stainless steel. This design gives you the quality necessary for most medical and pharmaceutical applications at an affordable price.

TOP PLATE MODELS

| Wheel Diameter (Inches) | Tread Width (Inches) | Wheel Description | Capacity (Lbs) | Load Height (Inches) | Swivel Radius (Inches) | Wheel Bearing | Model Number |
|-------------------------|----------------------|--------------------|----------------|----------------------|------------------------|---------------|----------------------|
| 4 | 2 | Phenolic | 800 | 5-5/8 | 3-3/8 | Roller | SS-04PHR-200-SW-TP03 |
| 4 | 2 | Phenolic | 800 | 5-5/8 | 3-3/8 | Delrin | SS-04PHD-200-SW-TP03 |
| 4 | 2 | Nylon | 800 | 5-5/8 | 3-3/8 | Roller | SS-04NYR-200-SW-TP03 |
| 4 | 2 | Nylon | 800 | 5-5/8 | 3-3/8 | Delrin | SS-04NYD-200-SW-TP03 |
| 4 | 2 | Polyurethane Solid | 800 | 5-5/8 | 3-3/8 | Roller | SS-04PSR-200-SW-TP03 |
| 4 | 2 | Polyurethane Solid | 800 | 5-5/8 | 3-3/8 | Delrin | SS-04PSD-200-SW-TP03 |
| 4 | 2 | Polyolefin | 800 | 5-5/8 | 3-3/8 | Roller | SS-04PPR-200-SW-TP03 |
| 4 | 2 | Polyolefin | 800 | 5-5/8 | 3-3/8 | Delrin | SS-04PPD-200-SW-TP03 |



Continues next page.

TOP PLATE FITTING

Swivel Top Plate Pattern

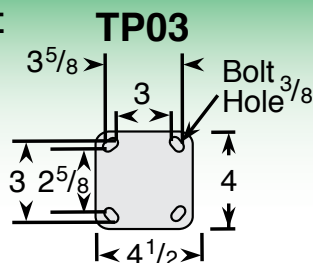

STAINLESS STEEL SIDE LOCK BRAKE

| Wheel Diameter | Kit Number |
|----------------|------------|
| 4" | SS04200 |
| 5" | SS05200 |
| 6" | SS06200 |
| 8" | SS08200 |

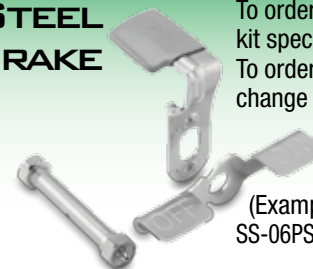

To order field installable kit specify kit number. To order on caster change fork code from "SW" to "TB"

(Example: SS-06PSR-200-TB-TP03)

STAINLESS STEEL (SS)

TOP PLATE MODELS

FREE SWIVEL • TOTAL LOCK
2" TREAD WIDTH

Continues from previous page.

| Wheel Diameter (Inches) | Tread Width (Inches) | Wheel Description | Capacity (Lbs) | Load Height (Inches) | Swivel Radius (Inches) | Wheel Bearing | Model Number |
|-------------------------|----------------------|--------------------|----------------|----------------------|------------------------|---------------|----------------------|
| 5 | 2 | Phenolic | 900 | 6-1/2 | 4-1/8 | Roller | SS-05PHR-200-SW-TP03 |
| 5 | 2 | Phenolic | 900 | 6-1/2 | 4-1/8 | Delrin | SS-05PHD-200-SW-TP03 |
| 5 | 2 | Nylon | 900 | 6-1/2 | 4-1/8 | Roller | SS-05NYR-200-SW-TP03 |
| 5 | 2 | Nylon | 900 | 6-1/2 | 4-1/8 | Delrin | SS-05NYD-200-SW-TP03 |
| 5 | 2 | Polyurethane Solid | 900 | 6-1/2 | 4-1/8 | Roller | SS-05PSR-200-SW-TP03 |
| 5 | 2 | Polyurethane Solid | 900 | 6-1/2 | 4-1/8 | Delrin | SS-05PSD-200-SW-TP03 |
| 5 | 2 | Polyolefin | 900 | 6-1/2 | 4-1/8 | Roller | SS-05PPR-200-SW-TP03 |
| 5 | 2 | Polyolefin | 900 | 6-1/2 | 4-1/8 | Delrin | SS-05PPD-200-SW-TP03 |
| 6 | 2 | Phenolic | 900 | 7-1/2 | 4-3/4 | Roller | SS-06PHR-200-SW-TP03 |
| 6 | 2 | Phenolic | 900 | 7-1/2 | 4-3/4 | Delrin | SS-06PHD-200-SW-TP03 |
| 6 | 2 | Nylon | 900 | 7-1/2 | 4-3/4 | Roller | SS-06NYR-200-SW-TP03 |
| 6 | 2 | Nylon | 900 | 7-1/2 | 4-3/4 | Delrin | SS-06NYD-200-SW-TP03 |
| 6 | 2 | Polyurethane Solid | 900 | 7-1/2 | 4-3/4 | Roller | SS-06PSR-200-SW-TP03 |
| 6 | 2 | Polyurethane Solid | 900 | 7-1/2 | 4-3/4 | Delrin | SS-06PSD-200-SW-TP03 |
| 6 | 2 | Polyolefin | 900 | 7-1/2 | 4-3/4 | Roller | SS-06PPR-200-SW-TP03 |
| 6 | 2 | Polyolefin | 900 | 7-1/2 | 4-3/4 | Delrin | SS-06PPD-200-SW-TP03 |
| 8 | 2 | Phenolic | 900 | 9-1/2 | 5-3/4 | Roller | SS-08PHR-200-SW-TP03 |
| 8 | 2 | Phenolic | 900 | 9-1/2 | 5-3/4 | Delrin | SS-08PHD-200-SW-TP03 |
| 8 | 2 | Nylon | 900 | 9-1/2 | 5-3/4 | Roller | SS-08NYR-200-SW-TP03 |
| 8 | 2 | Nylon | 900 | 9-1/2 | 5-3/4 | Delrin | SS-08NYD-200-SW-TP03 |
| 8 | 2 | Polyurethane Solid | 900 | 9-1/2 | 5-3/4 | Roller | SS-08PSR-200-SW-TP03 |
| 8 | 2 | Polyurethane Solid | 900 | 9-1/2 | 5-3/4 | Delrin | SS-08PSD-200-SW-TP03 |
| 8 | 2 | Polyolefin | 900 | 9-1/2 | 5-3/4 | Roller | SS-08PPR-200-SW-TP03 |
| 8 | 2 | Polyolefin | 900 | 9-1/2 | 5-3/4 | Delrin | SS-08PPD-200-SW-TP03 |



Stainless Steel Roller Bearings available, change bearing designation to S, example SS-08PHS200-SW-TP03.
Stainless Steel Precision Bearings available on some models, please consult factory.
Stainless wheel brakes are available for swivel models, Change SW to TB.
Rigid models are available, change SW to RG.

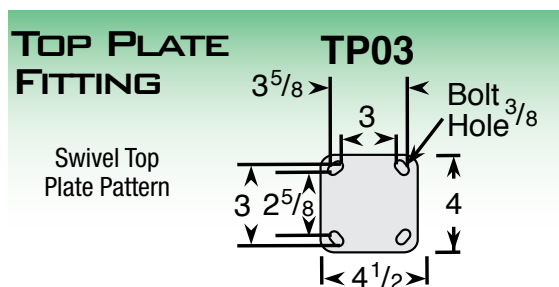

STAINLESS STEEL (SS)

TOP PLATE MODELS

FREE SWIVEL • TOTAL LOCK
2" TREAD WIDTH

TOP PLATE TOTAL LOCK MODELS

(LOCKS WHEEL AND SWIVEL)

| Wheel Diameter (Inches) | Tread Width (Inches) | Wheel Description | Capacity (Lbs) | Load Height (Inches) | Swivel Radius (Inches) | Wheel Bearing | Model Number |
|-------------------------|----------------------|--------------------|----------------|----------------------|------------------------|---------------|----------------------|
| 4 | 2 | Phenolic | 800 | 5-5/8 | 3-3/8 | Roller | SS-04PHR-200-TL-TP03 |
| 4 | 2 | Phenolic | 800 | 5-5/8 | 3-3/8 | Delrin | SS-04PHD-200-TL-TP03 |
| 4 | 2 | Nylon | 800 | 5-5/8 | 3-3/8 | Roller | SS-04NYR-200-TL-TP03 |
| 4 | 2 | Nylon | 800 | 5-5/8 | 3-3/8 | Delrin | SS-04NYD-200-TL-TP03 |
| 4 | 2 | Polyurethane Solid | 800 | 5-5/8 | 3-3/8 | Roller | SS-04PSR-200-TL-TP03 |
| 4 | 2 | Polyurethane Solid | 800 | 5-5/8 | 3-3/8 | Delrin | SS-04PSD-200-TL-TP03 |
| 4 | 2 | Polyolefin | 800 | 5-5/8 | 3-3/8 | Roller | SS-04PPR-200-TL-TP03 |
| 4 | 2 | Polyolefin | 800 | 5-5/8 | 3-3/8 | Delrin | SS-04PPD-200-TL-TP03 |
| 5 | 2 | Phenolic | 900 | 6-1/2 | 4-1/8 | Roller | SS-05PHR-200-TL-TP03 |
| 5 | 2 | Phenolic | 900 | 6-1/2 | 4-1/8 | Delrin | SS-05PHD-200-TL-TP03 |
| 5 | 2 | Nylon | 900 | 6-1/2 | 4-1/8 | Roller | SS-05NYR-200-TL-TP03 |
| 5 | 2 | Nylon | 900 | 6-1/2 | 4-1/8 | Delrin | SS-05NYD-200-TL-TP03 |
| 5 | 2 | Polyurethane Solid | 900 | 6-1/2 | 4-1/8 | Roller | SS-05PSR-200-TL-TP03 |
| 5 | 2 | Polyurethane Solid | 900 | 6-1/2 | 4-1/8 | Delrin | SS-05PSD-200-TL-TP03 |
| 5 | 2 | Polyolefin | 900 | 6-1/2 | 4-1/8 | Roller | SS-05PPR-200-TL-TP03 |
| 5 | 2 | Polyolefin | 900 | 6-1/2 | 4-1/8 | Delrin | SS-05PPD-200-TL-TP03 |
| 6 | 2 | Phenolic | 900 | 7-1/2 | 4-3/4 | Roller | SS-06PHR-200-TL-TP03 |
| 6 | 2 | Phenolic | 900 | 7-1/2 | 4-3/4 | Delrin | SS-06PHD-200-TL-TP03 |
| 6 | 2 | Nylon | 900 | 7-1/2 | 4-3/4 | Roller | SS-06NYR-200-TL-TP03 |
| 6 | 2 | Nylon | 900 | 7-1/2 | 4-3/4 | Delrin | SS-06NYD-200-TL-TP03 |
| 6 | 2 | Polyurethane Solid | 900 | 7-1/2 | 4-3/4 | Roller | SS-06PSR-200-TL-TP03 |
| 6 | 2 | Polyurethane Solid | 900 | 7-1/2 | 4-3/4 | Delrin | SS-06PSD-200-TL-TP03 |
| 6 | 2 | Polyolefin | 900 | 7-1/2 | 4-3/4 | Roller | SS-06PPR-200-TL-TP03 |
| 6 | 2 | Polyolefin | 900 | 7-1/2 | 4-3/4 | Delrin | SS-06PPD-200-TL-TP03 |
| 8 | 2 | Phenolic | 900 | 9-1/2 | 5-3/4 | Roller | SS-08PHR-200-TL-TP03 |
| 8 | 2 | Phenolic | 900 | 9-1/2 | 5-3/4 | Delrin | SS-08PHD-200-TL-TP03 |
| 8 | 2 | Nylon | 900 | 9-1/2 | 5-3/4 | Roller | SS-08NYR-200-TL-TP03 |
| 8 | 2 | Nylon | 900 | 9-1/2 | 5-3/4 | Delrin | SS-08NYD-200-TL-TP03 |
| 8 | 2 | Polyurethane Solid | 900 | 9-1/2 | 5-3/4 | Roller | SS-08PSR-200-TL-TP03 |
| 8 | 2 | Polyurethane Solid | 900 | 9-1/2 | 5-3/4 | Delrin | SS-08PSD-200-TL-TP03 |
| 8 | 2 | Polyolefin | 900 | 9-1/2 | 5-3/4 | Roller | SS-08PPR-200-TL-TP03 |
| 8 | 2 | Polyolefin | 900 | 9-1/2 | 5-3/4 | Delrin | SS-08PPD-200-TL-TP03 |



"NG" Next Generation

NYLON CASTERS – THE INSIDE STORY



3" thru 6" wheel diameters available.

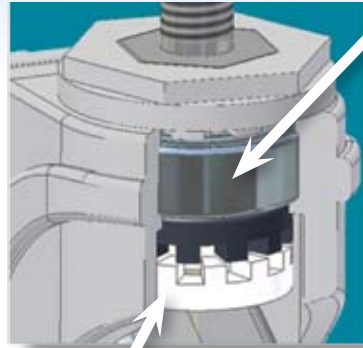

Direction and Total Lock braking action designed into caster.

NG series has precision sealed ball bearing raceway design for long lasting, smooth, quiet, maintenance free ride. Precision ball bearings are insert molded into the swivel raceway. Caster capacity is similar to steel wheels at a massive 325 lbs with 5" wheel.

PERFORMANCE FEATURES

- **QUIET**
- **CLEAN**
- **SMOOTH**
- **MAINTENANCE FREE**
- **HIGHER CAPACITY**

PERFORMANCE OPTIONS

- **304 STAINLESS STEEL FITTINGS AND COMPONENTS (NS SERIES)**
- **ANTI-STATIC MODELS (NA/PA MODELS)**
- **PREVENZ ANTI-MICROBIAL MODELS**



Custom Colors Available

Glass filled nylon for added strength and durability. Custom colors available.

Sealed precision bearing is insert molded into the swivel raceway.

Wheels feature sealed precision ball bearings to provide a smooth, quiet and maintenance free ride.

Recessed nut and bolt axles with covers allow for easy wheel replacement. Blue cover  is Nylon Plus stainless steel, yellow cover  is anti-static, and green cover  is antimicrobial.

Fully Integrated thread guards prevent the pick-up of string, sutures and foreign debris.

Caster is resistant to most chemicals. Excellent for wash down applications.

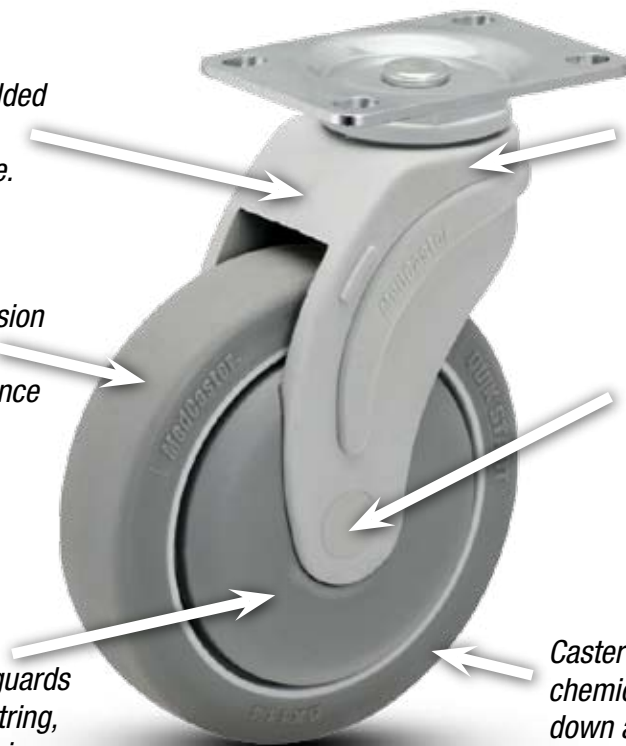

NEXT GENERATION NYLON (NG)

TOP PLATE MODELS

FREE SWIVEL • TOTAL LOCK • DIRECTION LOCK



- APPLICATIONS**
- Food Service Equipment
 - Case Carts
 - Utility Carts
 - Medical Equipment
 - Institutional Equipment
 - Hospital Carts
 - Animal Cage Carts

- FEATURES**
- Maintenance free
 - Sealed precision bearing raceway, smooth and quiet
 - Total Lock Brake models lock both swivel and wheel
 - Directional lock models lock swivel only (helps with steering)
 - Wheels feature sealed precision ball bearings and full thread guards
 - Resistance to most chemicals
 - Zinc plated top plate
 - Recessed axle with plastic cap covers



Custom Colors Available



Precision sealed ball bearing raceway design for smooth, quiet maintenance free ride.

Our NG series is made of glass filled nylon for added strength and durability. Precision ball bearings are insert molded into the swivel raceway.

SWIVEL TOP PLATE MODELS

Precision sealed ball bearing raceway design for smooth, quiet maintenance free ride.

| Wheel Diameter (Inches) | Tread Width (Inches) | Wheel Description | Capacity (Lbs) | Load Height Inches (mm) | Swivel Radius Inches (mm) | Wheel Bearing | Model Number |
|-------------------------|----------------------|--------------------|----------------|-------------------------|---------------------------|----------------|----------------------|
| 3 | 1-1/4 | QuikStart TPR | 200 | 4-9/32" (109) | 2-13/16" (72) | Precision Ball | NG-03QDP-125-SW-TP01 |
| 3 | 1-1/4 | QuikStart TPR | 200 | 4-9/32" (109) | 2-13/16" (72) | Plain | NG-03QDO-125-SW-TP01 |
| 3 | 1-1/4 | Anti-Microbial TPR | 200 | 4-9/32" (109) | 2-13/16" (72) | Precision Ball | NG-03AMP-125-SW-TP01 |
| 4 | 1-1/4 | QuikStart TPR | 275 | 5-9/16" (141) | 3-1/2" (89) | Precision Ball | NG-04QDP-125-SW-TP01 |
| 4 | 1-1/4 | Anti-Microbial TPR | 275 | 5-9/16" (141) | 3-1/2" (89) | Precision Ball | NG-04AMP-125-SW-TP01 |
| 5 | 1-1/4 | QuikStart TPR | 325 | 6-7/8" (174) | 3-1/2" (89) | Precision Ball | NG-05QDP-125-SW-TP01 |
| 5 | 1-1/4 | Anti-Microbial TPR | 325 | 6-7/8" (174) | 3-1/2" (89) | Precision Ball | NG-05AMP-125-SW-TP01 |
| 6 | 1-1/4 | QuikStart TPR | 325 | 7-11/16" (194) | 4-5/8" (117) | Precision Ball | NG-06QDP-125-SW-TP01 |
| 6 | 1-1/4 | QuikStart TPR | 325 | 7-11/16" (194) | 4-5/8" (117) | Plain | NG-06QDO-125-SW-TP01 |
| 6 | 1-1/4 | Anti-Microbial TPR | 325 | 7-11/16" (194) | 4-5/8" (117) | Precision Ball | NG-06AMP-125-SW-TP01 |



Rigid model available for 5" and 6" diameter wheels. Change SW to RG.



Anti-Static models available!
Change Series code from "NG" to "NA".
Example: **NA-03QDP-125-SW-TP01**

TOP PLATE FITTING

Swivel Top Plate Pattern

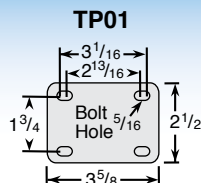

NEXT GENERATION NYLON (NG)

TOP PLATE MODELS

FREE SWIVEL • TOTAL LOCK • DIRECTION LOCK

SWIVEL TOP PLATE TOTAL LOCK MODELS

(LOCKS WHEEL AND SWIVEL)

Precision sealed ball bearing raceway design for smooth, quiet maintenance free ride.

| Wheel Diameter (Inches) | Tread Width (Inches) | Wheel Description | Capacity (Lbs) | Load Height Inches (mm) | Swivel Radius Inches (mm) | Wheel Bearing | Model Number |
|-------------------------|----------------------|--------------------|----------------|-------------------------|---------------------------|----------------|----------------------|
| 3 | 1-1/4 | QuikStart TPR | 200 | 4-9/32" (109) | 3-3/4" (96) | Precision Ball | NG-03QDP-125-TL-TP01 |
| 3 | 1-1/4 | QuikStart TPR | 200 | 4-9/32" (109) | 3-3/4" (96) | Plain | NG-03QDO-125-TL-TP01 |
| 3 | 1-1/4 | Anti-Microbial TPR | 200 | 4-9/32" (109) | 3-3/4" (96) | Precision Ball | NG-03AMP-125-TL-TP01 |
| 4 | 1-1/4 | QuikStart TPR | 275 | 5-9/16" (141) | 4-15/16" (125) | Precision Ball | NG-04QDP-125-TL-TP01 |
| 4 | 1-1/4 | Anti-Microbial TPR | 275 | 5-9/16" (141) | 4-15/16" (125) | Precision Ball | NG-04AMP-125-TL-TP01 |
| 5 | 1-1/4 | QuikStart TPR | 325 | 6-7/8" (174) | 4-15/16" (125) | Precision Ball | NG-05QDP-125-TL-TP01 |
| 5 | 1-1/4 | Anti-Microbial TPR | 325 | 6-7/8" (174) | 4-15/16" (125) | Precision Ball | NG-05AMP-125-TL-TP01 |
| 6 | 1-1/4 | QuikStart TPR | 325 | 7-11/16" (194) | 4-5/8" (117) | Precision Ball | NG-06QDP-125-TL-TP01 |
| 6 | 1-1/4 | QuikStart TPR | 325 | 7-11/16" (194) | 4-5/8" (117) | Plain | NG-06QDO-125-TL-TP01 |
| 6 | 1-1/4 | Anti-Microbial TPR | 325 | 7-11/16" (194) | 4-5/8" (117) | Precision Ball | NG-06AMP-125-TL-TP01 |



SWIVEL TOP PLATE DIRECTION LOCK MODELS

(LOCKS SWIVEL ONLY)

Precision sealed ball bearing raceway design for smooth, quiet maintenance free ride.

| Wheel Diameter (Inches) | Tread Width (Inches) | Wheel Description | Capacity (Lbs) | Load Height Inches (mm) | Swivel Radius Inches (mm) | Wheel Bearing | Model Number |
|-------------------------|----------------------|--------------------|----------------|-------------------------|---------------------------|----------------|----------------------|
| 3 | 1-1/4 | QuikStart TPR | 200 | 4-9/32" (109) | 3-3/4" (96) | Precision Ball | NG-03QDP-125-DL-TP01 |
| 3 | 1-1/4 | QuikStart TPR | 200 | 4-9/32" (109) | 3-3/4" (96) | Plain | NG-03QDO-125-DL-TP01 |
| 3 | 1-1/4 | Anti-Microbial TPR | 200 | 4-9/32" (109) | 3-3/4" (96) | Precision Ball | NG-03AMP-125-DL-TP01 |
| 4 | 1-1/4 | QuikStart TPR | 275 | 5-9/16" (141) | 4-15/16" (125) | Precision Ball | NG-04QDP-125-DL-TP01 |
| 4 | 1-1/4 | Anti-Microbial TPR | 275 | 5-9/16" (141) | 4-15/16" (125) | Precision Ball | NG-04AMP-125-DL-TP01 |
| 5 | 1-1/4 | QuikStart TPR | 325 | 6-7/8" (174) | 4-15/16" (125) | Precision Ball | NG-05QDP-125-DL-TP01 |
| 5 | 1-1/4 | Anti-Microbial TPR | 325 | 6-7/8" (174) | 4-15/16" (125) | Precision Ball | NG-05AMP-125-DL-TP01 |
| 6 | 1-1/4 | QuikStart TPR | 325 | 7-11/16" (194) | 4-5/8" (117) | Precision Ball | NG-06QDP-125-DL-TP01 |
| 6 | 1-1/4 | QuikStart TPR | 325 | 7-11/16" (194) | 4-5/8" (117) | Plain | NG-06QDO-125-DL-TP01 |
| 6 | 1-1/4 | Anti-Microbial TPR | 325 | 7-11/16" (194) | 4-5/8" (117) | Precision Ball | NG-06AMP-125-DL-TP01 |



Our Directional Lock casters are designed to lock the swivel but not the wheel allowing you to steer your equipment. The directional lock feature is designed to break free under heavier load when the unit is traversing a corner only to lock back into position when the unit resumes a straight course.

TOP PLATE FITTING

Swivel Top
Plate Pattern

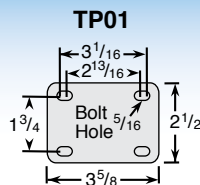

NEXT GENERATION NYLON (NG)

HOLLOW KINGPIN MODELS
FREE SWIVEL • TOTAL LOCK • DIRECTION LOCK



- APPLICATIONS**
- Food Service Equipment
 - Case Carts
 - Utility Carts
 - Medical Equipment
 - Institutional Equipment
 - Hospital Carts
 - Animal Cage Carts



Custom Colors Available



Precision sealed ball bearing raceway design for smooth, quiet maintenance free ride.

- FEATURES**
- Maintenance free
 - Sealed precision bearing raceway, smooth and quiet
 - Total Lock Brake models lock both swivel and wheel
 - Directional lock models lock swivel only (helps with steering)
 - Wheels feature sealed precision ball bearings and full thread guards
 - Resistance to most chemicals
 - Zinc plated top plate
 - Recessed axle with plastic cap covers

Our NG series is made of glass filled nylon for added strength and durability. Precision ball bearings are insert molded into the swivel raceway.

HOLLOW KINGPIN MODELS

Precision sealed ball bearing raceway design for smooth, quiet maintenance free ride.

| Wheel Diameter (Inches) | Tread Width (Inches) | Wheel Description | Capacity (Lbs) | Load Height Inches (mm) | Swivel Radius Inches (mm) | Wheel Bearing | Model Number |
|-------------------------|----------------------|--------------------|----------------|-------------------------|---------------------------|----------------|----------------------|
| 3 | 1-1/4 | QuikStart TPR | 200 | 4-9/64" (105) | 3-3/4" (95) | Precision Ball | NG-03QDP-125-SW-HKU1 |
| 3 | 1-1/4 | QuikStart TPR | 200 | 4-9/64" (105) | 3-3/4" (95) | Plain | NG-03QDO-125-SW-HKU1 |
| 3 | 1-1/4 | Anti-Microbial TPR | 200 | 4-9/64" (105) | 3-3/4" (95) | Precision Ball | NG-03AMP-125-SW-HKU1 |
| 4 | 1-1/4 | QuikStart TPR | 275 | 5-13/32" (137) | 3-1/2" (89) | Precision Ball | NG-04QDP-125-SW-HKU1 |
| 4 | 1-1/4 | Anti-Microbial TPR | 275 | 5-13/32" (137) | 3-1/2" (89) | Precision Ball | NG-04AMP-125-SW-HKU1 |
| 5 | 1-1/4 | QuikStart TPR | 325 | 6-1/2" (165) | 3-1/2" (89) | Precision Ball | NG-05QDP-125-SW-HKU1 |
| 5 | 1-1/4 | Anti-Microbial TPR | 325 | 6-1/2" (165) | 3-1/2" (89) | Precision Ball | NG-05AMP-125-SW-HKU1 |
| 6 | 1-1/4 | QuikStart TPR | 325 | 7-1/2" (191) | 4-5/8" (117) | Precision Ball | NG-06QDP-125-SW-HKU1 |
| 6 | 1-1/4 | QuikStart TPR | 325 | 7-1/2" (191) | 4-5/8" (117) | Plain | NG-06QDO-125-SW-HKU1 |
| 6 | 1-1/4 | Anti-Microbial TPR | 325 | 7-1/2" (191) | 4-5/8" (117) | Precision Ball | NG-06AMP-125-SW-HKU1 |



Anti-Static models available!
Change Series code from "NG" to "NA".
Example: **NA-03QDP-125-SW-HKU1**

HOLLOW KINGPIN

Caster is provided unassembled to make it easy to add your choice of fitting. If you would like these assembled change HKU1 to HKO1. 3/8" I.D. on 3" diam. models; 1/2" I.D. on 4", 5", & 6" diam. models.



NEXT GENERATION NYLON (NG)

HOLLOW KINGPIN MODELS
FREE SWIVEL • TOTAL LOCK • DIRECTION LOCK

HOLLOW KINGPIN TOTAL LOCK MODELS (LOCKS WHEEL AND SWIVEL)

Precision sealed ball bearing raceway design for smooth, quiet maintenance free ride.

| Wheel Diameter (Inches) | Tread Width (Inches) | Wheel Description | Capacity (lbs) | Load Height Inches (mm) | Swivel Radius Inches (mm) | Wheel Bearing | Model Number |
|-------------------------|----------------------|--------------------|----------------|-------------------------|---------------------------|----------------|----------------------|
| 3 | 1-1/4 | QuikStart TPR | 200 | 4-1/8" (105) | 3-3/4" (96) | Precision Ball | NG-03QDP-125-TL-HKU1 |
| 3 | 1-1/4 | QuikStart TPR | 200 | 4-1/8" (105) | 3-3/4" (96) | Plain | NG-03QDO-125-TL-HKU1 |
| 3 | 1-1/4 | Anti-Microbial TPR | 200 | 4-1/8" (105) | 3-3/4" (96) | Precision Ball | NG-03AMP-125-TL-HKU1 |
| 4 | 1-1/4 | QuikStart TPR | 275 | 5-13/32" (137) | 4-15/16" (125) | Precision Ball | NG-04QDP-125-TL-HKU1 |
| 4 | 1-1/4 | Anti-Microbial TPR | 275 | 5-13/32" (137) | 4-15/16" (125) | Precision Ball | NG-04AMP-125-TL-HKU1 |
| 5 | 1-1/4 | QuikStart TPR | 325 | 6-1/2" (165) | 4-15/16" (125) | Precision Ball | NG-05QDP-125-TL-HKU1 |
| 5 | 1-1/4 | Anti-Microbial TPR | 325 | 6-1/2" (165) | 4-15/16" (125) | Precision Ball | NG-05AMP-125-TL-HKU1 |
| 6 | 1-1/4 | QuikStart TPR | 325 | 7-1/2" (191) | 4-5/8" (117) | Precision Ball | NG-06QDP-125-TL-HKU1 |
| 6 | 1-1/4 | QuikStart TPR | 325 | 7-1/2" (191) | 4-5/8" (117) | Plain | NG-06QDO-125-TL-HKU1 |
| 6 | 1-1/4 | Anti-Microbial TPR | 325 | 7-1/2" (191) | 4-5/8" (117) | Precision Ball | NG-06AMP-125-TL-HKU1 |



HOLLOW KINGPIN DIRECTION LOCK MODELS (LOCKS SWIVEL ONLY)

Precision sealed ball bearing raceway design for smooth, quiet maintenance free ride.

Precision sealed ball bearing raceway design for smooth, quiet maintenance free ride.

| Wheel Diameter (Inches) | Tread Width (Inches) | Wheel Description | Capacity (lbs) | Load Height Inches (mm) | Swivel Radius Inches (mm) | Wheel Bearing | Model Number |
|-------------------------|----------------------|--------------------|----------------|-------------------------|---------------------------|----------------|----------------------|
| 3 | 1-1/4 | QuikStart TPR | 200 | 4-1/8" (105) | 3-3/4" (96) | Precision Ball | NG-03QDP-125-DL-HKU1 |
| 3 | 1-1/4 | QuikStart TPR | 200 | 4-1/8" (105) | 3-3/4" (96) | Plain | NG-03QDO-125-DL-HKU1 |
| 3 | 1-1/4 | Anti-Microbial TPR | 200 | 4-1/8" (105) | 3-3/4" (96) | Precision Ball | NG-03AMP-125-DL-HKU1 |
| 4 | 1-1/4 | QuikStart TPR | 275 | 5-13/32" (137) | 4-15/16" (125) | Precision Ball | NG-04QDP-125-DL-HKU1 |
| 4 | 1-1/4 | Anti-Microbial TPR | 275 | 5-13/32" (137) | 4-15/16" (125) | Precision Ball | NG-04AMP-125-DL-HKU1 |
| 5 | 1-1/4 | QuikStart TPR | 325 | 6-1/2" (165) | 4-15/16" (125) | Precision Ball | NG-05QDP-125-DL-HKU1 |
| 5 | 1-1/4 | Anti-Microbial TPR | 325 | 6-1/2" (165) | 4-15/16" (125) | Precision Ball | NG-05AMP-125-DL-HKU1 |
| 6 | 1-1/4 | QuikStart TPR | 325 | 7-1/2" (191) | 4-5/8" (117) | Precision Ball | NG-06QDP-125-DL-HKU1 |
| 6 | 1-1/4 | QuikStart TPR | 325 | 7-1/2" (191) | 4-5/8" (117) | Plain | NG-06QDO-125-DL-HKU1 |
| 6 | 1-1/4 | Anti-Microbial TPR | 325 | 7-1/2" (191) | 4-5/8" (117) | Precision Ball | NG-06AMP-125-DL-HKU1 |



Our Directional Lock casters are designed to lock the swivel but not the wheel allowing you to steer your equipment. The directional lock feature is designed to break free under heavier load when the unit is traversing a corner only to lock back into position when the unit resumes a straight course.

HOLLOW KINGPIN

Caster is provided unassembled to make it easy to add your choice of fitting. If you would like these assembled change HKU1 to HKO1. 3/8" I.D. on 3" diam. models; 1/2" I.D. on 4", 5", & 6" diam. models.



NEXT GENERATION NYLON (NG)

GRIP RING STEM MODELS

FREE SWIVEL • TOTAL LOCK • DIRECTION LOCK



- APPLICATIONS**
- Food Service Equipment
 - Case Carts
 - Utility Carts
 - Medical Equipment
 - Institutional Equipment
 - Hospital Carts
 - Animal Cage Carts

- FEATURES**
- Maintenance free
 - Sealed precision bearing raceway, smooth and quiet
 - Total Lock Brake models lock both swivel and wheel
 - Directional lock models lock swivel only (helps with steering)
 - Wheels feature sealed precision ball bearings and full thread guards
 - Resistance to most chemicals
 - Zinc plated top plate
 - Recessed axle with plastic cap covers



Custom Colors Available



Precision sealed ball bearing raceway design for smooth, quiet maintenance free ride.

Our NG series is made of glass filled nylon for added strength and durability. Precision ball bearings are insert molded into the swivel raceway.

GRIP RING STEM MODELS

Precision sealed ball bearing raceway design for smooth, quiet maintenance free ride.

| Wheel Diameter (Inches) | Tread Width (Inches) | Wheel Description | Capacity (Lbs) | Load Height Inches (mm) | Swivel Radius Inches (mm) | Wheel Bearing | Model Number |
|-------------------------|----------------------|--------------------|----------------|-------------------------|---------------------------|----------------|---------------------|
| 3 | 1-1/4 | QuikStart TPR | 200 | 4-9/64" (105) | 3-3/4" (95) | Precision Ball | NG-03QDP-125-SW-___ |
| 3 | 1-1/4 | QuikStart TPR | 200 | 4-9/64" (105) | 3-3/4" (95) | Plain | NG-03QDO-125-SW-___ |
| 3 | 1-1/4 | Anti-Microbial TPR | 200 | 4-9/64" (105) | 3-3/4" (95) | Precision Ball | NG-03AMP-125-SW-___ |
| 4 | 1-1/4 | QuikStart TPR | 275 | 5-13/32" (137) | 3-1/2" (89) | Precision Ball | NG-04QDP-125-SW-___ |
| 4 | 1-1/4 | Anti-Microbial TPR | 275 | 5-13/32" (137) | 3-1/2" (89) | Precision Ball | NG-04AMP-125-SW-___ |
| 5 | 1-1/4 | QuikStart TPR | 325 | 6-1/2" (165) | 3-1/2" (89) | Precision Ball | NG-05QDP-125-SW-___ |
| 5 | 1-1/4 | Anti-Microbial TPR | 325 | 6-1/2" (165) | 3-1/2" (89) | Precision Ball | NG-05AMP-125-SW-___ |
| 6 | 1-1/4 | QuikStart TPR | 325 | 7-1/2" (191) | 4-5/8" (117) | Precision Ball | NG-06QDP-125-SW-___ |
| 6 | 1-1/4 | QuikStart TPR | 325 | 7-1/2" (191) | 4-5/8" (117) | Plain | NG-06QDO-125-SW-___ |
| 6 | 1-1/4 | Anti-Microbial TPR | 325 | 7-1/2" (191) | 4-5/8" (117) | Precision Ball | NG-06AMP-125-SW-___ |



Anti-Static models available!
Change Series code from "NG" to "NA".
Example: **NA-03QDP-125-SW-GR02**

Specify Grip Ring Stem (GR) code, see fittings below for dimensions.

GRIP RING STEM FITTINGS

See fittings page for more options.

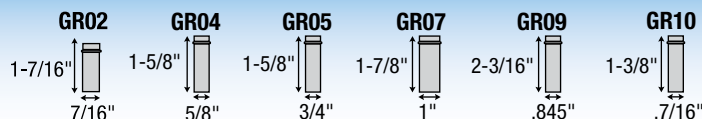

NEXT GENERATION NYLON (NG)

GRIP RING STEM MODELS
FREE SWIVEL • TOTAL LOCK • DIRECTION LOCK

GRIP RING STEM TOTAL LOCK MODELS

(LOCKS WHEEL AND SWIVEL)

Precision sealed ball bearing raceway design for smooth, quiet maintenance free ride.

| Wheel Diameter (Inches) | Tread Width (Inches) | Wheel Description | Capacity (lbs) | Load Height Inches (mm) | Swivel Radius Inches (mm) | Wheel Bearing | Model Number |
|-------------------------|----------------------|--------------------|----------------|-------------------------|---------------------------|----------------|---------------------|
| 3 | 1-1/4 | QuikStart TPR | 200 | 4-1/8" (105) | 3-3/4" (96) | Precision Ball | NG-03QDP-125-TL-___ |
| 3 | 1-1/4 | QuikStart TPR | 200 | 4-1/8" (105) | 3-3/4" (96) | Plain | NG-03QDO-125-TL-___ |
| 3 | 1-1/4 | Anti-Microbial TPR | 200 | 4-1/8" (105) | 3-3/4" (96) | Precision Ball | NG-03AMP-125-TL-___ |
| 4 | 1-1/4 | QuikStart TPR | 275 | 5-13/32" (137) | 4-15/16" (125) | Precision Ball | NG-04QDP-125-TL-___ |
| 4 | 1-1/4 | Anti-Microbial TPR | 275 | 5-13/32" (137) | 4-15/16" (125) | Precision Ball | NG-04AMP-125-TL-___ |
| 5 | 1-1/4 | QuikStart TPR | 325 | 6-1/2" (165) | 4-15/16" (125) | Precision Ball | NG-05QDP-125-TL-___ |
| 5 | 1-1/4 | Anti-Microbial TPR | 325 | 6-1/2" (165) | 4-15/16" (125) | Precision Ball | NG-05AMP-125-TL-___ |
| 6 | 1-1/4 | QuikStart TPR | 325 | 7-1/2" (191) | 4-5/8" (117) | Precision Ball | NG-06QDP-125-TL-___ |
| 6 | 1-1/4 | QuikStart TPR | 325 | 7-1/2" (191) | 4-5/8" (117) | Plain | NG-06QDO-125-TL-___ |
| 6 | 1-1/4 | Anti-Microbial TPR | 325 | 7-1/2" (191) | 4-5/8" (117) | Precision Ball | NG-06AMP-125-TL-___ |



GRIP RING STEM DIRECTION LOCK MODELS

(LOCKS SWIVEL ONLY)

Precision sealed ball bearing raceway design for smooth, quiet maintenance free ride.

| Wheel Diameter (Inches) | Tread Width (Inches) | Wheel Description | Capacity (lbs) | Load Height Inches (mm) | Swivel Radius Inches (mm) | Wheel Bearing | Model Number |
|-------------------------|----------------------|--------------------|----------------|-------------------------|---------------------------|----------------|---------------------|
| 3 | 1-1/4 | QuikStart TPR | 200 | 4-1/8" (105) | 3-3/4" (96) | Precision Ball | NG-03QDP-125-DL-___ |
| 3 | 1-1/4 | QuikStart TPR | 200 | 4-1/8" (105) | 3-3/4" (96) | Plain | NG-03QDO-125-DL-___ |
| 3 | 1-1/4 | Anti-Microbial TPR | 200 | 4-1/8" (105) | 3-3/4" (96) | Precision Ball | NG-03AMP-125-DL-___ |
| 4 | 1-1/4 | QuikStart TPR | 275 | 5-13/32" (137) | 4-15/16" (125) | Precision Ball | NG-04QDP-125-DL-___ |
| 4 | 1-1/4 | Anti-Microbial TPR | 275 | 5-13/32" (137) | 4-15/16" (125) | Precision Ball | NG-04AMP-125-DL-___ |
| 5 | 1-1/4 | QuikStart TPR | 325 | 6-1/2" (165) | 4-15/16" (125) | Precision Ball | NG-05QDP-125-DL-___ |
| 5 | 1-1/4 | Anti-Microbial TPR | 325 | 6-1/2" (165) | 4-15/16" (125) | Precision Ball | NG-05AMP-125-DL-___ |
| 6 | 1-1/4 | QuikStart TPR | 325 | 7-1/2" (191) | 4-5/8" (117) | Precision Ball | NG-06QDP-125-DL-___ |
| 6 | 1-1/4 | QuikStart TPR | 325 | 7-1/2" (191) | 4-5/8" (117) | Plain | NG-06QDO-125-DL-___ |
| 6 | 1-1/4 | Anti-Microbial TPR | 325 | 7-1/2" (191) | 4-5/8" (117) | Precision Ball | NG-06AMP-125-DL-___ |



Our Directional Lock casters are designed to lock the swivel but not the wheel allowing you to steer your equipment. The directional lock feature is designed to break free under heavier load when the unit is traversing a corner only to lock back into position when the unit resumes a straight course.

Specify Grip Ring Stem (GR) code, see fittings below for dimensions.

GRIP RING STEM FITTINGS

See fittings page for more options.

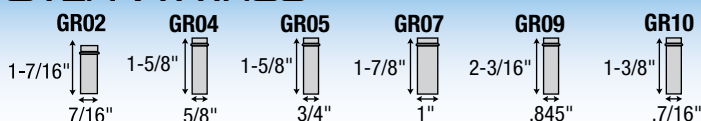

NEXT GENERATION NYLON (NG)

EXPANDING ADAPTER STEM MODELS
FREE SWIVEL • TOTAL LOCK • DIRECTION LOCK



- APPLICATIONS**
- Food Service Equipment
 - Case Carts
 - Utility Carts
 - Medical Equipment
 - Institutional Equipment
 - Hospital Carts
 - Animal Cage Carts



Custom Colors Available



Precision sealed ball bearing raceway design for smooth, quiet maintenance free ride.

- FEATURES**
- Maintenance free
 - Sealed precision bearing raceway, smooth and quiet
 - Total Lock Brake models lock both swivel and wheel
 - Directional lock models lock swivel only (helps with steering)
 - Wheels feature sealed precision ball bearings and full thread guards
 - Resistance to most chemicals
 - Zinc plated top plate
 - Recessed axle with plastic cap covers

Our NG series is made of glass filled nylon for added strength and durability. Precision ball bearings are insert molded into the swivel raceway.

EXPANDING ADAPTER STEM MODELS

Precision sealed ball bearing raceway design for smooth, quiet maintenance free ride.

| Wheel Diameter (Inches) | Tread Width (Inches) | Wheel Description | Capacity (Lbs) | Load Height Inches (mm) | Swivel Radius Inches (mm) | Wheel Bearing | Model Number |
|-------------------------|----------------------|--------------------|----------------|-------------------------|---------------------------|----------------|---------------------|
| 3 | 1-1/4 | QuikStart TPR | 200 | 4-9/64" (105) | 3-3/4" (95) | Precision Ball | NG-03QDP-125-SW-___ |
| 3 | 1-1/4 | QuikStart TPR | 200 | 4-9/64" (105) | 3-3/4" (95) | Plain | NG-03QDO-125-SW-___ |
| 3 | 1-1/4 | Anti-Microbial TPR | 200 | 4-9/64" (105) | 3-3/4" (95) | Precision Ball | NG-03AMP-125-SW-___ |
| 4 | 1-1/4 | QuikStart TPR | 275 | 5-13/32" (137) | 3-1/2" (89) | Precision Ball | NG-04QDP-125-SW-___ |
| 4 | 1-1/4 | Anti-Microbial TPR | 275 | 5-13/32" (137) | 3-1/2" (89) | Precision Ball | NG-04AMP-125-SW-___ |
| 5 | 1-1/4 | QuikStart TPR | 325 | 6-1/2" (165) | 3-1/2" (89) | Precision Ball | NG-05QDP-125-SW-___ |
| 5 | 1-1/4 | Anti-Microbial TPR | 325 | 6-1/2" (165) | 3-1/2" (89) | Precision Ball | NG-05AMP-125-SW-___ |
| 6 | 1-1/4 | QuikStart TPR | 325 | 7-1/2" (191) | 4-5/8" (117) | Precision Ball | NG-06QDP-125-SW-___ |
| 6 | 1-1/4 | QuikStart TPR | 325 | 7-1/2" (191) | 4-5/8" (117) | Plain | NG-06QDO-125-SW-___ |
| 6 | 1-1/4 | Anti-Microbial TPR | 325 | 7-1/2" (191) | 4-5/8" (117) | Precision Ball | NG-06AMP-125-SW-___ |



Anti-Static models available!
Change Series code from "NG" to "NA".
Example: **NA-03QDP-125-SW-XRN1**

Specify Expanding Adapter Stem (XR) code, see fittings below for dimensions:

EXPANDING ADAPTER STEM FITTINGS

See fittings page for more options.

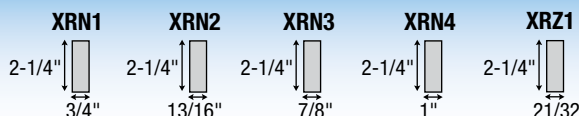

NEXT GENERATION NYLON (NG)

EXPANDING ADAPTER STEM MODELS
FREE SWIVEL • TOTAL LOCK • DIRECTION LOCK

EXPANDING ADAPTER STEM TOTAL LOCK MODELS (LOCKS WHEEL AND SWIVEL)

Precision sealed ball bearing raceway design for smooth, quiet maintenance free ride.

| Wheel Diameter (Inches) | Tread Width (Inches) | Wheel Description | Capacity (Lbs) | Load Height Inches (mm) | Swivel Radius Inches (mm) | Wheel Bearing | Model Number |
|-------------------------|----------------------|--------------------|----------------|-------------------------|---------------------------|----------------|--------------------|
| 3 | 1-1/4 | QuikStart TPR | 200 | 4-1/8" (105) | 3-3/4" (96) | Precision Ball | NG-03QDP-125-TL-__ |
| 3 | 1-1/4 | QuikStart TPR | 200 | 4-1/8" (105) | 3-3/4" (96) | Plain | NG-03QDO-125-TL-__ |
| 3 | 1-1/4 | Anti-Microbial TPR | 200 | 4-1/8" (105) | 3-3/4" (96) | Precision Ball | NG-03AMP-125-TL-__ |
| 4 | 1-1/4 | QuikStart TPR | 275 | 5-13/32" (137) | 4-15/16" (125) | Precision Ball | NG-04QDP-125-TL-__ |
| 4 | 1-1/4 | Anti-Microbial TPR | 275 | 5-13/32" (137) | 4-15/16" (125) | Precision Ball | NG-04AMP-125-TL-__ |
| 5 | 1-1/4 | QuikStart TPR | 325 | 6-1/2" (165) | 4-15/16" (125) | Precision Ball | NG-05QDP-125-TL-__ |
| 5 | 1-1/4 | Anti-Microbial TPR | 325 | 6-1/2" (165) | 4-15/16" (125) | Precision Ball | NG-05AMP-125-TL-__ |
| 6 | 1-1/4 | QuikStart TPR | 325 | 7-1/2" (191) | 4-5/8" (117) | Precision Ball | NG-06QDP-125-TL-__ |
| 6 | 1-1/4 | QuikStart TPR | 325 | 7-1/2" (191) | 4-5/8" (117) | Plain | NG-06QDO-125-TL-__ |
| 6 | 1-1/4 | Anti-Microbial TPR | 325 | 7-1/2" (191) | 4-5/8" (117) | Precision Ball | NG-06AMP-125-TL-__ |



EXPANDING ADAPTER STEM DIRECTION LOCK MODELS (LOCKS SWIVEL ONLY)

| Wheel Diameter (Inches) | Tread Width (Inches) | Wheel Description | Capacity (Lbs) | Load Height Inches (mm) | Swivel Radius Inches (mm) | Wheel Bearing | Model Number |
|-------------------------|----------------------|--------------------|----------------|-------------------------|---------------------------|----------------|--------------------|
| 3 | 1-1/4 | QuikStart TPR | 200 | 4-1/8" (105) | 3-3/4" (96) | Precision Ball | NG-03QDP-125-DL-__ |
| 3 | 1-1/4 | QuikStart TPR | 200 | 4-1/8" (105) | 3-3/4" (96) | Plain | NG-03QDO-125-DL-__ |
| 3 | 1-1/4 | Anti-Microbial TPR | 200 | 4-1/8" (105) | 3-3/4" (96) | Precision Ball | NG-03AMP-125-DL-__ |
| 4 | 1-1/4 | QuikStart TPR | 275 | 5-13/32" (137) | 4-15/16" (125) | Precision Ball | NG-04QDP-125-DL-__ |
| 4 | 1-1/4 | Anti-Microbial TPR | 275 | 5-13/32" (137) | 4-15/16" (125) | Precision Ball | NG-04AMP-125-DL-__ |
| 5 | 1-1/4 | QuikStart TPR | 325 | 6-1/2" (165) | 4-15/16" (125) | Precision Ball | NG-05QDP-125-DL-__ |
| 5 | 1-1/4 | Anti-Microbial TPR | 325 | 6-1/2" (165) | 4-15/16" (125) | Precision Ball | NG-05AMP-125-DL-__ |
| 6 | 1-1/4 | QuikStart TPR | 325 | 7-1/2" (191) | 4-5/8" (117) | Precision Ball | NG-06QDP-125-DL-__ |
| 6 | 1-1/4 | QuikStart TPR | 325 | 7-1/2" (191) | 4-5/8" (117) | Plain | NG-06QDO-125-DL-__ |
| 6 | 1-1/4 | Anti-Microbial TPR | 325 | 7-1/2" (191) | 4-5/8" (117) | Precision Ball | NG-06AMP-125-DL-__ |



Our Directional Lock casters are designed to lock the swivel but not the wheel allowing you to steer your equipment. The directional lock feature is designed to break free under heavier load when the unit is traversing a corner only to lock back into position when the unit resumes a straight course.

Specify Expanding Adapter Stem (XR) code, see fittings below for dimensions:

EXPANDING ADAPTER STEM FITTINGS

See fittings page for more options.

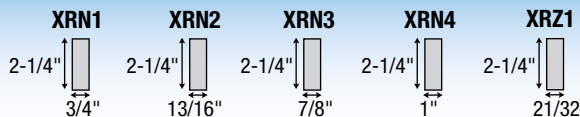

NEXT GENERATION NYLON (NG)

THREADED STEM MODELS
FREE SWIVEL • TOTAL LOCK • DIRECTION LOCK



- APPLICATIONS**
- Food Service Equipment
 - Case Carts
 - Utility Carts
 - Medical Equipment
 - Institutional Equipment
 - Hospital Carts
 - Animal Cage Carts

- FEATURES**
- Maintenance free
 - Sealed precision bearing raceway, smooth and quiet
 - Total Lock Brake models lock both swivel and wheel
 - Directional lock models lock swivel only (helps with steering)
 - Wheels feature sealed precision ball bearings and full thread guards
 - Resistance to most chemicals
 - Zinc plated top plate
 - Recessed axle with plastic cap covers



Custom Colors Available



Precision sealed ball bearing raceway design for smooth, quiet maintenance free ride.

Our NG series is made of glass filled nylon for added strength and durability. Precision ball bearings are insert molded into the swivel raceway.

THREADED STEM MODELS

Precision sealed ball bearing raceway design for smooth, quiet maintenance free ride.

| Wheel Diameter (Inches) | Tread Width (Inches) | Wheel Description | Capacity (Lbs) | Load Height Inches (mm) | Swivel Radius Inches (mm) | Wheel Bearing | Model Number |
|-------------------------|----------------------|--------------------|----------------|-------------------------|---------------------------|----------------|---------------------|
| 3 | 1-1/4 | QuikStart TPR | 200 | 4-9/64" (105) | 3-3/4" (95) | Precision Ball | NG-03QDP-125-SW-___ |
| 3 | 1-1/4 | QuikStart TPR | 200 | 4-9/64" (105) | 3-3/4" (95) | Plain | NG-03QDO-125-SW-___ |
| 3 | 1-1/4 | Anti-Microbial TPR | 200 | 4-9/64" (105) | 3-3/4" (95) | Precision Ball | NG-03AMP-125-SW-___ |
| 4 | 1-1/4 | QuikStart TPR | 275 | 5-13/32" (137) | 3-1/2" (89) | Precision Ball | NG-04QDP-125-SW-___ |
| 4 | 1-1/4 | Anti-Microbial TPR | 275 | 5-13/32" (137) | 3-1/2" (89) | Precision Ball | NG-04AMP-125-SW-___ |
| 5 | 1-1/4 | QuikStart TPR | 325 | 6-1/2" (165) | 3-1/2" (89) | Precision Ball | NG-05QDP-125-SW-___ |
| 5 | 1-1/4 | Anti-Microbial TPR | 325 | 6-1/2" (165) | 3-1/2" (89) | Precision Ball | NG-05AMP-125-SW-___ |
| 6 | 1-1/4 | QuikStart TPR | 325 | 7-1/2" (191) | 4-5/8" (117) | Precision Ball | NG-06QDP-125-SW-___ |
| 6 | 1-1/4 | QuikStart TPR | 325 | 7-1/2" (191) | 4-5/8" (117) | Plain | NG-06QDO-125-SW-___ |
| 6 | 1-1/4 | Anti-Microbial TPR | 325 | 7-1/2" (191) | 4-5/8" (117) | Precision Ball | NG-06AMP-125-SW-___ |



Anti-Static models available!
Change Series code from "NG" to "NA".
Example: **NA-03QDP-125-SW-TS02**

Specify Threaded Stem (TS) code, see fittings below for dimensions:

THREADED STEM FITTINGS

See fittings page for more options.

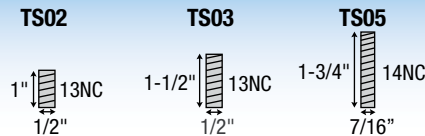

NEXT GENERATION NYLON (NG)

THREADED STEM MODELS

FREE SWIVEL • TOTAL LOCK • DIRECTION LOCK

THREADED STEM TOTAL LOCK MODELS (LOCKS WHEEL AND SWIVEL)

| Wheel Diameter (Inches) | Tread Width (Inches) | Wheel Description | Capacity (Lbs) | Load Height Inches (mm) | Swivel Radius Inches (mm) | Wheel Bearing | Model Number |
|-------------------------|----------------------|--------------------|----------------|-------------------------|---------------------------|----------------|--------------------|
| 3 | 1-1/4 | QuikStart TPR | 200 | 4-1/8" (105) | 3-3/4" (96) | Precision Ball | NG-03QDP-125-TL-__ |
| 3 | 1-1/4 | QuikStart TPR | 200 | 4-1/8" (105) | 3-3/4" (96) | Plain | NG-03QDO-125-TL-__ |
| 3 | 1-1/4 | Anti-Microbial TPR | 200 | 4-1/8" (105) | 3-3/4" (96) | Precision Ball | NG-03AMP-125-TL-__ |
| 4 | 1-1/4 | QuikStart TPR | 275 | 5-13/32" (137) | 4-15/16" (125) | Precision Ball | NG-04QDP-125-TL-__ |
| 4 | 1-1/4 | Anti-Microbial TPR | 275 | 5-13/32" (137) | 4-15/16" (125) | Precision Ball | NG-04AMP-125-TL-__ |
| 5 | 1-1/4 | QuikStart TPR | 325 | 6-1/2" (165) | 4-15/16" (125) | Precision Ball | NG-05QDP-125-TL-__ |
| 5 | 1-1/4 | Anti-Microbial TPR | 325 | 6-1/2" (165) | 4-15/16" (125) | Precision Ball | NG-05AMP-125-TL-__ |
| 6 | 1-1/4 | QuikStart TPR | 325 | 7-1/2" (191) | 4-5/8" (117) | Precision Ball | NG-06QDP-125-TL-__ |
| 6 | 1-1/4 | QuikStart TPR | 325 | 7-1/2" (191) | 4-5/8" (117) | Plain | NG-06QDO-125-TL-__ |
| 6 | 1-1/4 | Anti-Microbial TPR | 325 | 7-1/2" (191) | 4-5/8" (117) | Precision Ball | NG-06AMP-125-TL-__ |



THREADED STEM DIRECTION LOCK MODELS (LOCKS SWIVEL ONLY)

Precision sealed ball bearing raceway design for smooth, quiet maintenance free ride.

| Wheel Diameter (Inches) | Tread Width (Inches) | Wheel Description | Capacity (Lbs) | Load Height Inches (mm) | Swivel Radius Inches (mm) | Wheel Bearing | Model Number |
|-------------------------|----------------------|--------------------|----------------|-------------------------|---------------------------|----------------|--------------------|
| 3 | 1-1/4 | QuikStart TPR | 200 | 4-1/8" (105) | 3-3/4" (96) | Precision Ball | NG-03QDP-125-DL-__ |
| 3 | 1-1/4 | QuikStart TPR | 200 | 4-1/8" (105) | 3-3/4" (96) | Plain | NG-03QDO-125-DL-__ |
| 3 | 1-1/4 | Anti-Microbial TPR | 200 | 4-1/8" (105) | 3-3/4" (96) | Precision Ball | NG-03AMP-125-DL-__ |
| 4 | 1-1/4 | QuikStart TPR | 275 | 5-13/32" (137) | 4-15/16" (125) | Precision Ball | NG-04QDP-125-DL-__ |
| 4 | 1-1/4 | Anti-Microbial TPR | 275 | 5-13/32" (137) | 4-15/16" (125) | Precision Ball | NG-04AMP-125-DL-__ |
| 5 | 1-1/4 | QuikStart TPR | 325 | 6-1/2" (165) | 4-15/16" (125) | Precision Ball | NG-05QDP-125-DL-__ |
| 5 | 1-1/4 | Anti-Microbial TPR | 325 | 6-1/2" (165) | 4-15/16" (125) | Precision Ball | NG-05AMP-125-DL-__ |
| 6 | 1-1/4 | QuikStart TPR | 325 | 7-1/2" (191) | 4-5/8" (117) | Precision Ball | NG-06QDP-125-DL-__ |
| 6 | 1-1/4 | QuikStart TPR | 325 | 7-1/2" (191) | 4-5/8" (117) | Plain | NG-06QDO-125-DL-__ |
| 6 | 1-1/4 | Anti-Microbial TPR | 325 | 7-1/2" (191) | 4-5/8" (117) | Precision Ball | NG-06AMP-125-DL-__ |



Our Directional Lock casters are designed to lock the swivel but not the wheel allowing you to steer your equipment. The directional lock feature is designed to break free under heavier load when the unit is traversing a corner only to lock back into position when the unit resumes a straight course.

THREADED STEM FITTINGS

Easy to install stem. See fittings page for more options.

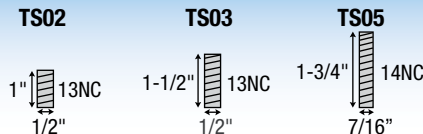

Specify Threaded Stem (TS) code, see fittings below for dimensions:

NEXT GENERATION NYLON (NG)

ROUND/SQUARE STEM MODELS
FREE SWIVEL • TOTAL LOCK • DIRECTION LOCK



- APPLICATIONS**
- Food Service Equipment
 - Case Carts
 - Utility Carts
 - Medical Equipment
 - Institutional Equipment
 - Hospital Carts
 - Animal Cage Carts



Custom Colors Available



Precision sealed ball bearing raceway design for smooth, quiet maintenance free ride.

- FEATURES**
- Maintenance free
 - Sealed precision bearing raceway, smooth and quiet
 - Total Lock Brake models lock both swivel and wheel
 - Directional lock models lock swivel only (helps with steering)
 - Wheels feature sealed precision ball bearings and full thread guards
 - Resistance to most chemicals
 - Zinc plated top plate
 - Recessed axle with plastic cap covers

Our NG series is made of glass filled nylon for added strength and durability. Precision ball bearings are insert molded into the swivel raceway.

ROUND OR SQUARE STEM MODELS

Precision sealed ball bearing raceway design for smooth, quiet maintenance free ride.

| Wheel Diameter (Inches) | Tread Width (Inches) | Wheel Description | Capacity (Lbs) | Load Height Inches (mm) | Swivel Radius Inches (mm) | Wheel Bearing | Model Number |
|-------------------------|----------------------|--------------------|----------------|-------------------------|---------------------------|----------------|---------------------|
| 3 | 1-1/4 | QuikStart TPR | 200 | 4-9/64" (105) | 3-3/4" (95) | Precision Ball | NG-03QDP-125-SW-___ |
| 3 | 1-1/4 | QuikStart TPR | 200 | 4-9/64" (105) | 3-3/4" (95) | Plain | NG-03QDO-125-SW-___ |
| 3 | 1-1/4 | Anti-Microbial TPR | 200 | 4-9/64" (105) | 3-3/4" (95) | Precision Ball | NG-03AMP-125-SW-___ |
| 4 | 1-1/4 | QuikStart TPR | 275 | 5-13/32" (137) | 3-1/2" (89) | Precision Ball | NG-04QDP-125-SW-___ |
| 4 | 1-1/4 | Anti-Microbial TPR | 275 | 5-13/32" (137) | 3-1/2" (89) | Precision Ball | NG-04AMP-125-SW-___ |
| 5 | 1-1/4 | QuikStart TPR | 325 | 6-1/2" (165) | 3-1/2" (89) | Precision Ball | NG-05QDP-125-SW-___ |
| 5 | 1-1/4 | Anti-Microbial TPR | 325 | 6-1/2" (165) | 3-1/2" (89) | Precision Ball | NG-05AMP-125-SW-___ |
| 6 | 1-1/4 | QuikStart TPR | 325 | 7-1/2" (191) | 4-5/8" (117) | Precision Ball | NG-06QDP-125-SW-___ |
| 6 | 1-1/4 | QuikStart TPR | 325 | 7-1/2" (191) | 4-5/8" (117) | Plain | NG-06QDO-125-SW-___ |
| 6 | 1-1/4 | Anti-Microbial TPR | 325 | 7-1/2" (191) | 4-5/8" (117) | Precision Ball | NG-06AMP-125-SW-___ |



Rigid model available for 5" and 6" diameter wheels. Change SW to RG.



Anti-Static models available!
Change Series code from "NG" to "NA".
Example: **NA-03QDP-125-SW-SQ01**

ROUND STEM FITTINGS

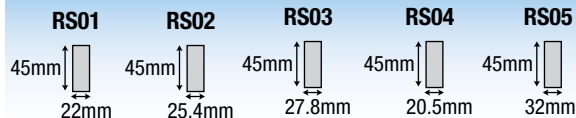

SQUARE STEM FITTINGS

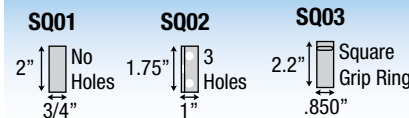

Specify Round Stem (RS) code, or Square Stem code (SQ) see fittings at left for dimensions.

See fittings page for more options.



NEXT GENERATION NYLON (NG)

ROUND/SQUARE STEM MODELS
FREE SWIVEL • TOTAL LOCK • DIRECTION LOCK

ROUND OR SQUARE STEM TOTAL LOCK MODELS (LOCKS WHEEL AND SWIVEL)

| Wheel Diameter (Inches) | Tread Width (Inches) | Wheel Description | Capacity (Lbs) | Load Height Inches (mm) | Swivel Radius Inches (mm) | Wheel Bearing | Model Number |
|-------------------------|----------------------|--------------------|----------------|-------------------------|---------------------------|----------------|---------------------|
| 3 | 1-1/4 | QuikStart TPR | 200 | 4-1/8" (105) | 3-3/4" (96) | Precision Ball | NG-03QDP-125-TL-___ |
| 3 | 1-1/4 | QuikStart TPR | 200 | 4-1/8" (105) | 3-3/4" (96) | Plain | NG-03QDO-125-TL-___ |
| 3 | 1-1/4 | Anti-Microbial TPR | 200 | 4-1/8" (105) | 3-3/4" (96) | Precision Ball | NG-03AMP-125-TL-___ |
| 4 | 1-1/4 | QuikStart TPR | 275 | 5-13/32" (137) | 4-15/16" (125) | Precision Ball | NG-04QDP-125-TL-___ |
| 4 | 1-1/4 | Anti-Microbial TPR | 275 | 5-13/32" (137) | 4-15/16" (125) | Precision Ball | NG-04AMP-125-TL-___ |
| 5 | 1-1/4 | QuikStart TPR | 325 | 6-1/2" (165) | 4-15/16" (125) | Precision Ball | NG-05QDP-125-TL-___ |
| 5 | 1-1/4 | Anti-Microbial TPR | 325 | 6-1/2" (165) | 4-15/16" (125) | Precision Ball | NG-05AMP-125-TL-___ |
| 6 | 1-1/4 | QuikStart TPR | 325 | 7-1/2" (191) | 4-5/8" (117) | Precision Ball | NG-06QDP-125-TL-___ |
| 6 | 1-1/4 | QuikStart TPR | 325 | 7-1/2" (191) | 4-5/8" (117) | Plain | NG-06QDO-125-TL-___ |
| 6 | 1-1/4 | Anti-Microbial TPR | 325 | 7-1/2" (191) | 4-5/8" (117) | Precision Ball | NG-06AMP-125-TL-___ |



ROUND OR SQUARE STEM DIRECTION LOCK MODELS (LOCKS SWIVEL ONLY)

Precision sealed ball bearing raceway design for smooth, quiet maintenance free ride.

| Wheel Diameter (Inches) | Tread Width (Inches) | Wheel Description | Capacity (Lbs) | Load Height Inches (mm) | Swivel Radius Inches (mm) | Wheel Bearing | Model Number |
|-------------------------|----------------------|--------------------|----------------|-------------------------|---------------------------|----------------|---------------------|
| 3 | 1-1/4 | QuikStart TPR | 200 | 4-1/8" (105) | 3-3/4" (96) | Precision Ball | NG-03QDP-125-DL-___ |
| 3 | 1-1/4 | QuikStart TPR | 200 | 4-1/8" (105) | 3-3/4" (96) | Plain | NG-03QDO-125-DL-___ |
| 3 | 1-1/4 | Anti-Microbial TPR | 200 | 4-1/8" (105) | 3-3/4" (96) | Precision Ball | NG-03AMP-125-DL-___ |
| 4 | 1-1/4 | QuikStart TPR | 275 | 5-13/32" (137) | 4-15/16" (125) | Precision Ball | NG-04QDP-125-DL-___ |
| 4 | 1-1/4 | Anti-Microbial TPR | 275 | 5-13/32" (137) | 4-15/16" (125) | Precision Ball | NG-04AMP-125-DL-___ |
| 5 | 1-1/4 | QuikStart TPR | 325 | 6-1/2" (165) | 4-15/16" (125) | Precision Ball | NG-05QDP-125-DL-___ |
| 5 | 1-1/4 | Anti-Microbial TPR | 325 | 6-1/2" (165) | 4-15/16" (125) | Precision Ball | NG-05AMP-125-DL-___ |
| 6 | 1-1/4 | QuikStart TPR | 325 | 7-1/2" (191) | 4-5/8" (117) | Precision Ball | NG-06QDP-125-DL-___ |
| 6 | 1-1/4 | QuikStart TPR | 325 | 7-1/2" (191) | 4-5/8" (117) | Plain | NG-06QDO-125-DL-___ |
| 6 | 1-1/4 | Anti-Microbial TPR | 325 | 7-1/2" (191) | 4-5/8" (117) | Precision Ball | NG-06AMP-125-DL-___ |



Our Directional Lock casters are designed to lock the swivel but not the wheel allowing you to steer your equipment. The directional lock feature is designed to break free under heavier load when the unit is traversing a corner only to lock back into position when the unit resumes a straight course.

ROUND STEM FITTINGS

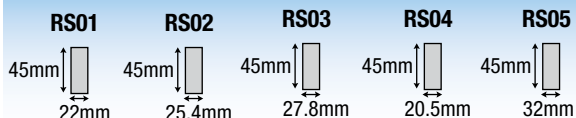

SQUARE STEM FITTINGS

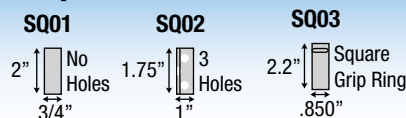

NYLON PLUS STAINLESS (NS)

TOP PLATE MODELS

FREE SWIVEL • TOTAL LOCK • DIRECTION LOCK



- APPLICATIONS**
- Food Service Equipment
 - Case Carts
 - Utility Carts
 - Medical Equipment
 - Institutional Equipment
 - Hospital Carts
 - Animal Cage Carts
 - Pharmaceutical Equipment

304 Stainless steel top plate and components!



Precision sealed ball bearing raceway design for smooth, quiet maintenance free ride.

- FEATURES**
- Sealed stainless steel precision bearing raceway, smooth and quiet
 - Total lock and direction lock brake models available
 - Wheels feature sealed stainless precision ball bearings and full thread guards
 - Resistant to most chemicals
 - Recessed Stainless axle with plastic cap covers
 - Maintenance free, requires no lubrication for rig or wheel

Our NS Series is similar to NG Series but with the added benefit of 304 stainless components making it excellent for wet environments.

SWIVEL TOP PLATE MODELS

Precision sealed ball bearing raceway design for smooth, quiet maintenance free ride.

| Wheel Diameter (Inches) | Tread Width (Inches) | Wheel Description | Capacity (Lbs) | Load Height Inches (mm) | Swivel Radius Inches (mm) | Wheel Bearing | Model Number |
|-------------------------|----------------------|--------------------|----------------|-------------------------|---------------------------|----------------|----------------------|
| 3 | 1-1/4 | QuikStart TPR | 200 | 4-9/32" (109) | 2-13/16" (72) | Precision Ball | NS-03QDP-125-SW-TP01 |
| 3 | 1-1/4 | QuikStart TPR | 200 | 4-9/32" (109) | 2-13/16" (72) | Plain | NS-03QDO-125-SW-TP01 |
| 3 | 1-1/4 | Anti-Microbial TPR | 200 | 4-9/32" (109) | 2-13/16" (72) | Precision Ball | NS-03AMP-125-SW-TP01 |
| 4 | 1-1/4 | QuikStart TPR | 275 | 5-9/16" (141) | 3-1/2" (89) | Precision Ball | NS-04QDP-125-SW-TP01 |
| 4 | 1-1/4 | Anti-Microbial TPR | 275 | 5-9/16" (141) | 3-1/2" (89) | Precision Ball | NS-04AMP-125-SW-TP01 |
| 5 | 1-1/4 | QuikStart TPR | 325 | 6-7/8" (174) | 3-1/2" (89) | Precision Ball | NS-05QDP-125-SW-TP01 |
| 5 | 1-1/4 | Anti-Microbial TPR | 325 | 6-7/8" (174) | 3-1/2" (89) | Precision Ball | NS-05AMP-125-SW-TP01 |
| 6 | 1-1/4 | QuikStart TPR | 325 | 7-11/16" (194) | 4-5/8" (117) | Precision Ball | NS-06QDP-125-SW-TP01 |
| 6 | 1-1/4 | QuikStart TPR | 325 | 7-11/16" (194) | 4-5/8" (117) | Plain | NS-06QDO-125-SW-TP01 |
| 6 | 1-1/4 | Anti-Microbial TPR | 325 | 7-11/16" (194) | 4-5/8" (117) | Precision Ball | NS-06AMP-125-SW-TP01 |



316SS fittings available for non-magnetic applications. Consult factory.

Rigid model available for 5" and 6" diameter wheels. Change SW to RG.

TOP PLATE FITTING

Swivel Top Plate Pattern

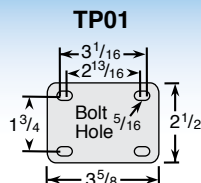

Custom Colors Available

NYLON PLUS STAINLESS (NS)

TOP PLATE MODELS

FREE SWIVEL • TOTAL LOCK • DIRECTION LOCK

SWIVEL TOP PLATE TOTAL LOCK MODELS

(LOCKS WHEEL AND SWIVEL)

Precision sealed ball bearing raceway design for smooth, quiet maintenance free ride.

| Wheel Diameter (Inches) | Tread Width (Inches) | Wheel Description | Capacity (Lbs) | Load Height Inches (mm) | Swivel Radius Inches (mm) | Wheel Bearing | Model Number |
|-------------------------|----------------------|--------------------|----------------|-------------------------|---------------------------|----------------|----------------------|
| 3 | 1-1/4 | QuikStart TPR | 200 | 4-9/32" (109) | 3-3/4" (96) | Precision Ball | NS-03QDP-125-TL-TP01 |
| 3 | 1-1/4 | QuikStart TPR | 200 | 4-9/32" (109) | 3-3/4" (96) | Plain | NS-03QDO-125-TL-TP01 |
| 3 | 1-1/4 | Anti-Microbial TPR | 200 | 4-9/32" (109) | 3-3/4" (96) | Precision Ball | NS-03AMP-125-TL-TP01 |
| 4 | 1-1/4 | QuikStart TPR | 275 | 5-9/16" (141) | 4-15/16" (125) | Precision Ball | NS-04QDP-125-TL-TP01 |
| 4 | 1-1/4 | Anti-Microbial TPR | 275 | 5-9/16" (141) | 4-15/16" (125) | Precision Ball | NS-04AMP-125-TL-TP01 |
| 5 | 1-1/4 | QuikStart TPR | 325 | 6-7/8" (174) | 4-15/16" (125) | Precision Ball | NS-05QDP-125-TL-TP01 |
| 5 | 1-1/4 | Anti-Microbial TPR | 325 | 6-7/8" (174) | 4-15/16" (125) | Precision Ball | NS-05AMP-125-TL-TP01 |
| 6 | 1-1/4 | QuikStart TPR | 325 | 7-11/16" (194) | 4-5/8" (117) | Precision Ball | NS-06QDP-125-TL-TP01 |
| 6 | 1-1/4 | QuikStart TPR | 325 | 7-11/16" (194) | 4-5/8" (117) | Plain | NS-06QDO-125-TL-TP01 |
| 6 | 1-1/4 | Anti-Microbial TPR | 325 | 7-11/16" (194) | 4-5/8" (117) | Precision Ball | NS-06AMP-125-TL-TP01 |



SWIVEL TOP PLATE DIRECTION LOCK MODELS

(LOCKS SWIVEL ONLY)

Precision sealed ball bearing raceway design for smooth, quiet maintenance free ride.

| Wheel Diameter (Inches) | Tread Width (Inches) | Wheel Description | Capacity (Lbs) | Load Height Inches (mm) | Swivel Radius Inches (mm) | Wheel Bearing | Model Number |
|-------------------------|----------------------|--------------------|----------------|-------------------------|---------------------------|----------------|----------------------|
| 3 | 1-1/4 | QuikStart TPR | 200 | 4-9/32" (109) | 3-3/4" (96) | Precision Ball | NS-03QDP-125-DL-TP01 |
| 3 | 1-1/4 | QuikStart TPR | 200 | 4-9/32" (109) | 3-3/4" (96) | Plain | NS-03QDO-125-DL-TP01 |
| 3 | 1-1/4 | Anti-Microbial TPR | 200 | 4-9/32" (109) | 3-3/4" (96) | Precision Ball | NS-03AMP-125-DL-TP01 |
| 4 | 1-1/4 | QuikStart TPR | 275 | 5-9/16" (141) | 4-15/16" (125) | Precision Ball | NS-04QDP-125-DL-TP01 |
| 4 | 1-1/4 | Anti-Microbial TPR | 275 | 5-9/16" (141) | 4-15/16" (125) | Precision Ball | NS-04AMP-125-DL-TP01 |
| 5 | 1-1/4 | QuikStart TPR | 325 | 6-7/8" (174) | 4-15/16" (125) | Precision Ball | NS-05QDP-125-DL-TP01 |
| 5 | 1-1/4 | Anti-Microbial TPR | 325 | 6-7/8" (174) | 4-15/16" (125) | Precision Ball | NS-05AMP-125-DL-TP01 |
| 6 | 1-1/4 | QuikStart TPR | 325 | 7-11/16" (194) | 4-5/8" (117) | Precision Ball | NS-06QDP-125-DL-TP01 |
| 6 | 1-1/4 | QuikStart TPR | 325 | 7-11/16" (194) | 4-5/8" (117) | Plain | NS-06QDO-125-DL-TP01 |
| 6 | 1-1/4 | Anti-Microbial TPR | 325 | 7-11/16" (194) | 4-5/8" (117) | Precision Ball | NS-06AMP-125-DL-TP01 |



Our Directional Lock casters are designed to lock the swivel but not the wheel allowing you to steer your equipment. The directional lock feature is designed to break free under heavier load when the unit is traversing a corner only to lock back into position when the unit resumes a straight course.

TOP PLATE FITTING

Swivel Top
Plate Pattern

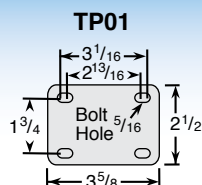

NYLON PLUS STAINLESS (NS)

HOLLOW KINGPIN MODELS
FREE SWIVEL • TOTAL LOCK • DIRECTION LOCK



- APPLICATIONS**
- Food Service Equipment
 - Case Carts
 - Utility Carts
 - Medical Equipment
 - Institutional Equipment
 - Hospital Carts
 - Animal Cage Carts
 - Pharmaceutical Equipment

304 Stainless steel components!

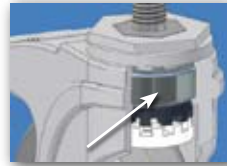

Precision sealed ball bearing raceway design for smooth, quiet maintenance free ride.

- FEATURES**
- Sealed stainless steel precision bearing raceway, smooth and quiet
 - Total lock and direction lock brake models available
 - Wheels feature sealed stainless precision ball bearings and full thread guards
 - Resistant to most chemicals
 - Recessed Stainless axle with plastic cap covers
 - Maintenance free, requires no lubrication for rig or wheel

Our NS Series is similar to NG Series but with the added benefit of 304 stainless components making it excellent for wet environments.

HOLLOW KINGPIN MODELS

Precision sealed ball bearing raceway design for smooth, quiet maintenance free ride.

| Wheel Diameter (Inches) | Tread Width (Inches) | Wheel Description | Capacity (Lbs) | Load Height Inches (mm) | Swivel Radius Inches (mm) | Wheel Bearing | Model Number |
|-------------------------|----------------------|--------------------|----------------|-------------------------|---------------------------|----------------|----------------------|
| 3 | 1-1/4 | QuikStart TPR | 200 | 4-9/64" (105) | 3-3/4" (95) | Precision Ball | NS-03QDP-125-SW-HKU1 |
| 3 | 1-1/4 | QuikStart TPR | 200 | 4-9/64" (105) | 3-3/4" (95) | Plain | NS-03QDO-125-SW-HKU1 |
| 3 | 1-1/4 | Anti-Microbial TPR | 200 | 4-9/64" (105) | 3-3/4" (95) | Precision Ball | NS-03AMP-125-SW-HKU1 |
| 4 | 1-1/4 | QuikStart TPR | 275 | 5-13/32" (137) | 3-1/2" (89) | Precision Ball | NS-04QDP-125-SW-HKU1 |
| 4 | 1-1/4 | Anti-Microbial TPR | 275 | 5-13/32" (137) | 3-1/2" (89) | Precision Ball | NS-04AMP-125-SW-HKU1 |
| 5 | 1-1/4 | QuikStart TPR | 325 | 6-1/2" (165) | 3-1/2" (89) | Precision Ball | NS-05QDP-125-SW-HKU1 |
| 5 | 1-1/4 | Anti-Microbial TPR | 325 | 6-1/2" (165) | 3-1/2" (89) | Precision Ball | NS-05AMP-125-SW-HKU1 |
| 6 | 1-1/4 | QuikStart TPR | 325 | 7-1/2" (191) | 4-5/8" (117) | Precision Ball | NS-06QDP-125-SW-HKU1 |
| 6 | 1-1/4 | QuikStart TPR | 325 | 7-1/2" (191) | 4-5/8" (117) | Plain | NS-06QDO-125-SW-HKU1 |
| 6 | 1-1/4 | Anti-Microbial TPR | 325 | 7-1/2" (191) | 4-5/8" (117) | Precision Ball | NS-06AMP-125-SW-HKU1 |



316SS fittings available for non-magnetic applications. Consult factory.

HOLLOW KINGPIN

Caster is provided unassembled to make it easy to add your choice of fitting. If you would like these assembled change from HKU1 to HKO1. 1/2 I.D.



Custom Colors Available



NYLON PLUS STAINLESS (NS)

HOLLOW KINGPIN MODELS
FREE SWIVEL • TOTAL LOCK • DIRECTION LOCK

HOLLOW KINGPIN TOTAL LOCK MODELS

(LOCKS WHEEL AND SWIVEL)

Precision sealed ball bearing raceway design for smooth, quiet maintenance free ride.

| Wheel Diameter (Inches) | Tread Width (Inches) | Wheel Description | Capacity (Lbs) | Load Height Inches (mm) | Swivel Radius Inches (mm) | Wheel Bearing | Model Number |
|-------------------------|----------------------|--------------------|----------------|-------------------------|---------------------------|----------------|----------------------|
| 3 | 1-1/4 | QuikStart TPR | 200 | 4-1/8" (105) | 3-3/4" (96) | Precision Ball | NS-03QDP-125-TL-HKU1 |
| 3 | 1-1/4 | QuikStart TPR | 200 | 4-1/8" (105) | 3-3/4" (96) | Plain | NS-03QDO-125-TL-HKU1 |
| 3 | 1-1/4 | Anti-Microbial TPR | 200 | 4-1/8" (105) | 3-3/4" (96) | Precision Ball | NS-03AMP-125-TL-HKU1 |
| 4 | 1-1/4 | QuikStart TPR | 275 | 5-13/32" (137) | 4-15/16" (125) | Precision Ball | NS-04QDP-125-TL-HKU1 |
| 4 | 1-1/4 | Anti-Microbial TPR | 275 | 5-13/32" (137) | 4-15/16" (125) | Precision Ball | NS-04AMP-125-TL-HKU1 |
| 5 | 1-1/4 | QuikStart TPR | 325 | 6-1/2" (165) | 4-15/16" (125) | Precision Ball | NS-05QDP-125-TL-HKU1 |
| 5 | 1-1/4 | Anti-Microbial TPR | 325 | 6-1/2" (165) | 4-15/16" (125) | Precision Ball | NS-05AMP-125-TL-HKU1 |
| 6 | 1-1/4 | QuikStart TPR | 325 | 7-1/2" (191) | 4-5/8" (117) | Precision Ball | NS-06QDP-125-TL-HKU1 |
| 6 | 1-1/4 | QuikStart TPR | 325 | 7-1/2" (191) | 4-5/8" (117) | Plain | NS-06QDO-125-TL-HKU1 |
| 6 | 1-1/4 | Anti-Microbial TPR | 325 | 7-1/2" (191) | 4-5/8" (117) | Precision Ball | NS-06AMP-125-TL-HKU1 |



HOLLOW KINGPIN DIRECTION LOCK MODELS

(LOCKS SWIVEL ONLY)

Precision sealed ball bearing raceway design for smooth, quiet maintenance free ride.

| Wheel Diameter (Inches) | Tread Width (Inches) | Wheel Description | Capacity (Lbs) | Load Height Inches (mm) | Swivel Radius Inches (mm) | Wheel Bearing | Model Number |
|-------------------------|----------------------|--------------------|----------------|-------------------------|---------------------------|----------------|----------------------|
| 3 | 1-1/4 | QuikStart TPR | 200 | 4-1/8" (105) | 3-3/4" (96) | Precision Ball | NS-03QDP-125-DL-HKU1 |
| 3 | 1-1/4 | QuikStart TPR | 200 | 4-1/8" (105) | 3-3/4" (96) | Plain | NS-03QDO-125-DL-HKU1 |
| 3 | 1-1/4 | Anti-Microbial TPR | 200 | 4-1/8" (105) | 3-3/4" (96) | Precision Ball | NS-03AMP-125-DL-HKU1 |
| 4 | 1-1/4 | QuikStart TPR | 275 | 5-13/32" (137) | 4-15/16" (125) | Precision Ball | NS-04QDP-125-DL-HKU1 |
| 4 | 1-1/4 | Anti-Microbial TPR | 275 | 5-13/32" (137) | 4-15/16" (125) | Precision Ball | NS-04AMP-125-DL-HKU1 |
| 5 | 1-1/4 | QuikStart TPR | 325 | 6-1/2" (165) | 4-15/16" (125) | Precision Ball | NS-05QDP-125-DL-HKU1 |
| 5 | 1-1/4 | Anti-Microbial TPR | 325 | 6-1/2" (165) | 4-15/16" (125) | Precision Ball | NS-05AMP-125-DL-HKU1 |
| 6 | 1-1/4 | QuikStart TPR | 325 | 7-1/2" (191) | 4-5/8" (117) | Precision Ball | NS-06QDP-125-DL-HKU1 |
| 6 | 1-1/4 | QuikStart TPR | 325 | 7-1/2" (191) | 4-5/8" (117) | Plain | NS-06QDO-125-DL-HKU1 |
| 6 | 1-1/4 | Anti-Microbial TPR | 325 | 7-1/2" (191) | 4-5/8" (117) | Precision Ball | NS-06AMP-125-DL-HKU1 |



Our Directional Lock casters are designed to lock the swivel but not the wheel allowing you to steer your equipment. The directional lock feature is designed to break free under heavier load when the unit is traversing a corner only to lock back into position when the unit resumes a straight course.

HOLLOW KINGPIN

Caster is provided unassembled to make it easy to add your choice of fitting. If you would like these assembled change from HKU1 to HKO1. 1/2 I.D.

NYLON PLUS STAINLESS (NS)

EXPANDING ADAPTER STEM MODELS
FREE SWIVEL • TOTAL LOCK • DIRECTION LOCK



- APPLIC**
- Food Service Equipment
 - Case Carts
 - Utility Carts
 - Medical Equipment
 - Institutional Equipment
 - Hospital Carts
 - Animal Cage Carts
 - Pharmaceutical Equipment

- FEATURES**
- Sealed stainless steel precision bearing raceway, smooth and quiet
 - Total lock and direction lock brake models available
 - Wheels feature sealed stainless precision ball bearings and full thread guards
 - Resistant to most chemicals
 - Recessed Stainless axle with plastic cap covers
 - Maintenance free, requires no lubrication for rig or wheel

304 Stainless steel components!



Precision sealed ball bearing raceway design for smooth, quiet maintenance free ride.

Our NS Series is similar to NG Series but with the added benefit of 304 stainless components making it excellent for wet environments.

EXPANDING ADAPTER STEM MODELS

Precision sealed ball bearing raceway design for smooth, quiet maintenance free ride.

| Wheel Diameter (Inches) | Tread Width (Inches) | Wheel Description | Capacity (Lbs) | Load Height Inches (mm) | Swivel Radius Inches (mm) | Wheel Bearing | Model Number |
|-------------------------|----------------------|--------------------|----------------|-------------------------|---------------------------|----------------|---------------------|
| 3 | 1-1/4 | QuikStart TPR | 200 | 4-9/64" (105) | 3-3/4" (95) | Precision Ball | NS-03QDP-125-SW-___ |
| 3 | 1-1/4 | QuikStart TPR | 200 | 4-9/64" (105) | 3-3/4" (95) | Plain | NS-03QDO-125-SW-___ |
| 3 | 1-1/4 | Anti-Microbial TPR | 200 | 4-9/64" (105) | 3-3/4" (95) | Precision Ball | NS-03AMP-125-SW-___ |
| 4 | 1-1/4 | QuikStart TPR | 275 | 5-13/32" (137) | 3-1/2" (89) | Precision Ball | NS-04QDP-125-SW-___ |
| 4 | 1-1/4 | Anti-Microbial TPR | 275 | 5-13/32" (137) | 3-1/2" (89) | Precision Ball | NS-04AMP-125-SW-___ |
| 5 | 1-1/4 | QuikStart TPR | 325 | 6-1/2" (165) | 3-1/2" (89) | Precision Ball | NS-05QDP-125-SW-___ |
| 5 | 1-1/4 | Anti-Microbial TPR | 325 | 6-1/2" (165) | 3-1/2" (89) | Precision Ball | NS-05AMP-125-SW-___ |
| 6 | 1-1/4 | QuikStart TPR | 325 | 7-1/2" (191) | 4-5/8" (117) | Precision Ball | NS-06QDP-125-SW-___ |
| 6 | 1-1/4 | QuikStart TPR | 325 | 7-1/2" (191) | 4-5/8" (117) | Plain | NS-06QDO-125-SW-___ |
| 6 | 1-1/4 | Anti-Microbial TPR | 325 | 7-1/2" (191) | 4-5/8" (117) | Precision Ball | NS-06AMP-125-SW-___ |



316SS fittings available for non-magnetic applications. Consult factory.

Specify Expanding Adapter Stem Round Nylon (XRN) code, Round Zamac (XRZ). see fittings at left for dimensions:

EXPANDING ADAPTER STEM FITTINGS

See fittings page for more options.

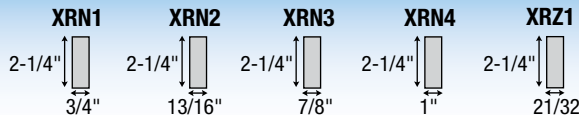

NYLON PLUS STAINLESS (NS)

EXPANDING ADAPTER STEM MODELS
FREE SWIVEL • TOTAL LOCK • DIRECTION LOCK

EXPANDING ADAPTER STEM TOTAL LOCK MODELS (LOCKS WHEEL AND SWIVEL)

Precision sealed ball bearing raceway design for smooth, quiet maintenance free ride.

| Wheel Diameter (Inches) | Tread Width (Inches) | Wheel Description | Capacity (Lbs) | Load Height Inches (mm) | Swivel Radius Inches (mm) | Wheel Bearing | Model Number |
|-------------------------|----------------------|--------------------|----------------|-------------------------|---------------------------|----------------|--------------------|
| 3 | 1-1/4 | QuikStart TPR | 200 | 4-1/8" (105) | 3-3/4" (96) | Precision Ball | NS-03QDP-125-TL-__ |
| 3 | 1-1/4 | QuikStart TPR | 200 | 4-1/8" (105) | 3-3/4" (96) | Plain | NS-03QDO-125-TL-__ |
| 3 | 1-1/4 | Anti-Microbial TPR | 200 | 4-1/8" (105) | 3-3/4" (96) | Precision Ball | NS-03AMP-125-TL-__ |
| 4 | 1-1/4 | QuikStart TPR | 275 | 5-13/32" (137) | 4-15/16" (125) | Precision Ball | NS-04QDP-125-TL-__ |
| 4 | 1-1/4 | Anti-Microbial TPR | 275 | 5-13/32" (137) | 4-15/16" (125) | Precision Ball | NS-04AMP-125-TL-__ |
| 5 | 1-1/4 | QuikStart TPR | 325 | 6-1/2" (165) | 4-15/16" (125) | Precision Ball | NS-05QDP-125-TL-__ |
| 5 | 1-1/4 | Anti-Microbial TPR | 325 | 6-1/2" (165) | 4-15/16" (125) | Precision Ball | NS-05AMP-125-TL-__ |
| 6 | 1-1/4 | QuikStart TPR | 325 | 7-1/2" (191) | 4-5/8" (117) | Precision Ball | NS-06QDP-125-TL-__ |
| 6 | 1-1/4 | QuikStart TPR | 325 | 7-1/2" (191) | 4-5/8" (117) | Plain | NS-06QDO-125-TL-__ |
| 6 | 1-1/4 | Anti-Microbial TPR | 325 | 7-1/2" (191) | 4-5/8" (117) | Precision Ball | NS-06AMP-125-TL-__ |



EXPANDING ADAPTER STEM DIRECTION LOCK MODELS (LOCKS SWIVEL ONLY)

Precision sealed ball bearing raceway design for smooth, quiet maintenance free ride.

| Wheel Diameter (Inches) | Tread Width (Inches) | Wheel Description | Capacity (Lbs) | Load Height Inches (mm) | Swivel Radius Inches (mm) | Wheel Bearing | Model Number |
|-------------------------|----------------------|--------------------|----------------|-------------------------|---------------------------|----------------|--------------------|
| 3 | 1-1/4 | QuikStart TPR | 200 | 4-1/8" (105) | 3-3/4" (96) | Precision Ball | NS-03QDP-125-DL-__ |
| 3 | 1-1/4 | QuikStart TPR | 200 | 4-1/8" (105) | 3-3/4" (96) | Plain | NS-03QDO-125-DL-__ |
| 3 | 1-1/4 | Anti-Microbial TPR | 200 | 4-1/8" (105) | 3-3/4" (96) | Precision Ball | NS-03AMP-125-DL-__ |
| 4 | 1-1/4 | QuikStart TPR | 275 | 5-13/32" (137) | 4-15/16" (125) | Precision Ball | NS-04QDP-125-DL-__ |
| 4 | 1-1/4 | Anti-Microbial TPR | 275 | 5-13/32" (137) | 4-15/16" (125) | Precision Ball | NS-04AMP-125-DL-__ |
| 5 | 1-1/4 | QuikStart TPR | 325 | 6-1/2" (165) | 4-15/16" (125) | Precision Ball | NS-05QDP-125-DL-__ |
| 5 | 1-1/4 | Anti-Microbial TPR | 325 | 6-1/2" (165) | 4-15/16" (125) | Precision Ball | NS-05AMP-125-DL-__ |
| 6 | 1-1/4 | QuikStart TPR | 325 | 7-1/2" (191) | 4-5/8" (117) | Precision Ball | NS-06QDP-125-DL-__ |
| 6 | 1-1/4 | QuikStart TPR | 325 | 7-1/2" (191) | 4-5/8" (117) | Plain | NS-06QDO-125-DL-__ |
| 6 | 1-1/4 | Anti-Microbial TPR | 325 | 7-1/2" (191) | 4-5/8" (117) | Precision Ball | NS-06AMP-125-DL-__ |



Our Directional Lock casters are designed to lock the swivel but not the wheel allowing you to steer your equipment. The directional lock feature is designed to break free under heavier load when the unit is traversing a corner only to lock back into position when the unit resumes a straight course.

Specify Expanding Adapter Stem Round Nylon (XRN) code, Round Zamac (XRZ). see fittings at left for dimensions:

EXPANDING ADAPTER STEM FITTINGS

See fittings page for more options.

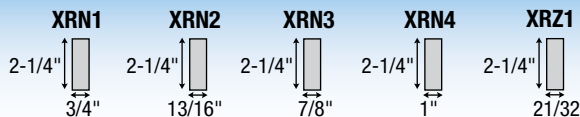

NYLON PLUS STAINLESS (NS)

THREADED STEM MODELS
FREE SWIVEL • TOTAL LOCK • DIRECTION LOCK



- APPLICATIONS**
- Food Service Equipment
 - Case Carts
 - Utility Carts
 - Medical Equipment
 - Institutional Equipment
 - Hospital Carts
 - Animal Cage Carts
 - Pharmaceutical Equipment

304 Stainless steel components!



Precision sealed ball bearing raceway design for smooth, quiet maintenance free ride.

- FEATURES**
- Sealed stainless steel precision bearing raceway, smooth and quiet
 - Total lock and direction lock brake models available
 - Wheels feature sealed stainless precision ball bearings and full thread guards
 - Resistant to most chemicals
 - Recessed Stainless axle with plastic cap covers
 - Maintenance free, requires no lubrication for rig or wheel

Our NS Series is similar to NG Series but with the added benefit of 304 stainless components making it excellent for wet environments.

THREADED STEM MODELS

Precision sealed ball bearing raceway design for smooth, quiet maintenance free ride.

| Wheel Diameter (Inches) | Tread Width (Inches) | Wheel Description | Capacity (Lbs) | Load Height Inches (mm) | Swivel Radius Inches (mm) | Wheel Bearing | Model Number |
|-------------------------|----------------------|--------------------|----------------|-------------------------|---------------------------|----------------|---------------------|
| 3 | 1-1/4 | QuikStart TPR | 200 | 4-9/64" (105) | 3-3/4" (95) | Precision Ball | NS-03QDP-125-SW-___ |
| 3 | 1-1/4 | QuikStart TPR | 200 | 4-9/64" (105) | 3-3/4" (95) | Plain | NS-03QDO-125-SW-___ |
| 3 | 1-1/4 | Anti-Microbial TPR | 200 | 4-9/64" (105) | 3-3/4" (95) | Precision Ball | NS-03AMP-125-SW-___ |
| 4 | 1-1/4 | QuikStart TPR | 275 | 5-13/32" (137) | 3-1/2" (89) | Precision Ball | NS-04QDP-125-SW-___ |
| 4 | 1-1/4 | Anti-Microbial TPR | 275 | 5-13/32" (137) | 3-1/2" (89) | Precision Ball | NS-04AMP-125-SW-___ |
| 5 | 1-1/4 | QuikStart TPR | 325 | 6-1/2" (165) | 3-1/2" (89) | Precision Ball | NS-05QDP-125-SW-___ |
| 5 | 1-1/4 | Anti-Microbial TPR | 325 | 6-1/2" (165) | 3-1/2" (89) | Precision Ball | NS-05AMP-125-SW-___ |
| 6 | 1-1/4 | QuikStart TPR | 325 | 7-1/2" (191) | 4-5/8" (117) | Precision Ball | NS-06QDP-125-SW-___ |
| 6 | 1-1/4 | QuikStart TPR | 325 | 7-1/2" (191) | 4-5/8" (117) | Plain | NS-06QDO-125-SW-___ |
| 6 | 1-1/4 | Anti-Microbial TPR | 325 | 7-1/2" (191) | 4-5/8" (117) | Precision Ball | NS-06AMP-125-SW-___ |



316SS fittings available for non-magnetic applications. Consult factory.

THREADED STEM FITTINGS

Stainless steel.
See fittings page for more options.

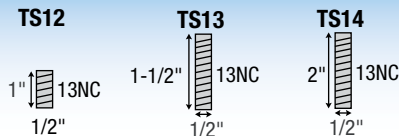

Specify Threaded Stem (TS) code, see fittings below for dimensions:

NYLON PLUS STAINLESS (NS)

THREADED STEM MODELS

FREE SWIVEL • TOTAL LOCK • DIRECTION LOCK

THREADED STEM TOTAL LOCK MODELS

(LOCKS WHEEL AND SWIVEL)

Precision sealed ball bearing raceway design for smooth, quiet maintenance free ride.

| Wheel Diameter (Inches) | Tread Width (Inches) | Wheel Description | Capacity (Lbs) | Load Height Inches (mm) | Swivel Radius Inches (mm) | Wheel Bearing | Model Number |
|-------------------------|----------------------|--------------------|----------------|-------------------------|---------------------------|----------------|---------------------|
| 3 | 1-1/4 | QuikStart TPR | 200 | 4-1/8" (105) | 3-3/4" (96) | Precision Ball | NS-03QDP-125-TL-___ |
| 3 | 1-1/4 | QuikStart TPR | 200 | 4-1/8" (105) | 3-3/4" (96) | Plain | NS-03QDO-125-TL-___ |
| 3 | 1-1/4 | Anti-Microbial TPR | 200 | 4-1/8" (105) | 3-3/4" (96) | Precision Ball | NS-03AMP-125-TL-___ |
| 4 | 1-1/4 | QuikStart TPR | 275 | 5-13/32" (137) | 4-15/16" (125) | Precision Ball | NS-04QDP-125-TL-___ |
| 4 | 1-1/4 | Anti-Microbial TPR | 275 | 5-13/32" (137) | 4-15/16" (125) | Precision Ball | NS-04AMP-125-TL-___ |
| 5 | 1-1/4 | QuikStart TPR | 325 | 6-1/2" (165) | 4-15/16" (125) | Precision Ball | NS-05QDP-125-TL-___ |
| 5 | 1-1/4 | Anti-Microbial TPR | 325 | 6-1/2" (165) | 4-15/16" (125) | Precision Ball | NS-05AMP-125-TL-___ |
| 6 | 1-1/4 | QuikStart TPR | 325 | 7-1/2" (191) | 4-5/8" (117) | Precision Ball | NS-06QDP-125-TL-___ |
| 6 | 1-1/4 | QuikStart TPR | 325 | 7-1/2" (191) | 4-5/8" (117) | Plain | NS-06QDO-125-TL-___ |
| 6 | 1-1/4 | Anti-Microbial TPR | 325 | 7-1/2" (191) | 4-5/8" (117) | Precision Ball | NS-06AMP-125-TL-___ |



THREADED STEM DIRECTION LOCK MODELS

(LOCKS SWIVEL ONLY)

Precision sealed ball bearing raceway design for smooth, quiet maintenance free ride.

| Wheel Diameter (Inches) | Tread Width (Inches) | Wheel Description | Capacity (Lbs) | Load Height Inches (mm) | Swivel Radius Inches (mm) | Wheel Bearing | Model Number |
|-------------------------|----------------------|--------------------|----------------|-------------------------|---------------------------|----------------|---------------------|
| 3 | 1-1/4 | QuikStart TPR | 200 | 4-1/8" (105) | 3-3/4" (96) | Precision Ball | NS-03QDP-125-DL-___ |
| 3 | 1-1/4 | QuikStart TPR | 200 | 4-1/8" (105) | 3-3/4" (96) | Plain | NS-03QDO-125-DL-___ |
| 3 | 1-1/4 | Anti-Microbial TPR | 200 | 4-1/8" (105) | 3-3/4" (96) | Precision Ball | NS-03AMP-125-DL-___ |
| 4 | 1-1/4 | QuikStart TPR | 275 | 5-13/32" (137) | 4-15/16" (125) | Precision Ball | NS-04QDP-125-DL-___ |
| 4 | 1-1/4 | Anti-Microbial TPR | 275 | 5-13/32" (137) | 4-15/16" (125) | Precision Ball | NS-04AMP-125-DL-___ |
| 5 | 1-1/4 | QuikStart TPR | 325 | 6-1/2" (165) | 4-15/16" (125) | Precision Ball | NS-05QDP-125-DL-___ |
| 5 | 1-1/4 | Anti-Microbial TPR | 325 | 6-1/2" (165) | 4-15/16" (125) | Precision Ball | NS-05AMP-125-DL-___ |
| 6 | 1-1/4 | QuikStart TPR | 325 | 7-1/2" (191) | 4-5/8" (117) | Precision Ball | NS-06QDP-125-DL-___ |
| 6 | 1-1/4 | QuikStart TPR | 325 | 7-1/2" (191) | 4-5/8" (117) | Plain | NS-06QDO-125-DL-___ |
| 6 | 1-1/4 | Anti-Microbial TPR | 325 | 7-1/2" (191) | 4-5/8" (117) | Precision Ball | NS-06AMP-125-DL-___ |



Our Directional Lock casters are designed to lock the swivel but not the wheel allowing you to steer your equipment. The directional lock feature is designed to break free under heavier load when the unit is traversing a corner only to lock back into position when the unit resumes a straight course.

Specify Threaded Stem (TS) code, see fittings below for dimensions:

THREADED STEM FITTINGS

Stainless steel.
See fittings page for more options.

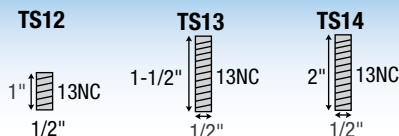

PLASTIC (PG)

TOP PLATE MODELS

FREE SWIVEL • TOTAL LOCK • DIRECTION LOCK



Standard color is silk grey

APPLICATIONS

- Food Service Equipment
- Case Carts
- Utility Carts
- Medical Equipment
- Institutional Equipment
- Hospital Carts
- Animal Cage Carts
- Cart Washable applications

4", 5", 6" & 8" wheel diameters

FEATURES

- Maintenance free
- Sealed precision bearing raceway
- Total Lock Brake models lock both swivel and wheel
- Directional lock models lock swivel only (helps with steering)
- Wheel feature precision bearings and full thread guards
- Rigs are made with glass filled nylon for added strength
- Resistance to most chemicals
- Recessed axle with plastic cap covers
- European style, yellow chromate top plate
- Operating temperatures good to 210° F intermittent

Our PG series provides you with that smooth European look and design.

SWIVEL TOP PLATE MODELS

| Wheel Diameter (Inches) | Tread Width (Inches) | Wheel Description | Capacity (Lbs) | Load Height Inches (mm) | Swivel Radius Inches (mm) | Wheel Bearing | Model Number |
|-------------------------|----------------------|-------------------|----------------|-------------------------|---------------------------|----------------|----------------------|
| 4 | 1-1/4 | Rubber on Plastic | 220 | 5-23/32" (145) | 3-15/32" (88) | Precision Ball | PG-04RPP-125-SW-TP01 |
| 4 | 1-1/4 | Polyurethane TPU | 220 | 5-23/32" (145) | 3-15/32" (88) | Precision Ball | PG-04PYP-125-SW-TP01 |
| 5 | 1-1/4 | Rubber on Plastic | 220 | 6-9/16" (165) | 4-5/6" (110) | Precision Ball | PG-05RPP-125-SW-TP01 |
| 5 | 1-1/4 | Polyurethane TPU | 220 | 6-9/16" (165) | 4-5/6" (110) | Precision Ball | PG-05PYP-125-SW-TP01 |
| 6 | 1-1/4 | Rubber on Plastic | 264 | 8-1/32" (195) | 4-57/64" (124) | Precision Ball | PG-06RPP-125-SW-TP01 |
| 6 | 1-1/4 | Polyurethane TPU | 264 | 8-1/32" (195) | 4-57/64" (124) | Precision Ball | PG-06PYP-125-SW-TP01 |
| 8 | 1-1/4 | Rubber on Plastic | 264 | 10-13/64" (251) | 6-9/16" (165) | Precision Ball | PG-08RPP-125-SW-TP01 |
| 8 | 1-1/4 | Polyurethane TPU | 264 | 10-13/64" (251) | 6-9/16" (165) | Precision Ball | PG-08PYP-125-SW-TP01 |



TOP PLATE FITTING

Swivel Top Plate Pattern

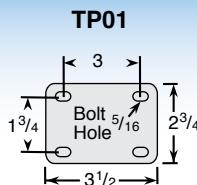

Dark grey also available, please consult factory.



PLASTIC (PG)

TOP PLATE MODELS

FREE SWIVEL • TOTAL LOCK • DIRECTION LOCK

SWIVEL TOP PLATE TOTAL LOCK MODELS

(LOCKS WHEEL AND SWIVEL)

| Wheel Diameter (Inches) | Tread Width (Inches) | Wheel Description | Capacity (Lbs) | Load Height Inches (mm) | Swivel Radius Inches (mm) | Wheel Bearing | Model Number |
|-------------------------|----------------------|-------------------|----------------|-------------------------|---------------------------|----------------|----------------------|
| 4 | 1-1/4 | Rubber on Plastic | 220 | 5-23/32" (145) | 4-21/64" (110) | Precision Ball | PG-04RPP-125-TL-TP01 |
| 4 | 1-1/4 | Polyurethane TPU | 220 | 5-23/32" (145) | 4-21/64" (110) | Precision Ball | PG-04PYP-125-TL-TP01 |
| 5 | 1-1/4 | Rubber on Plastic | 220 | 6-9/16" (165) | 4-23/32" (120) | Precision Ball | PG-05RPP-125-TL-TP01 |
| 5 | 1-1/4 | Polyurethane TPU | 220 | 6-9/16" (165) | 4-23/32" (120) | Precision Ball | PG-05PYP-125-TL-TP01 |
| 6 | 1-1/4 | Rubber on Plastic | 264 | 8-1/32" (195) | 5-9/32" (134) | Precision Ball | PG-06RPP-125-TL-TP01 |
| 6 | 1-1/4 | Polyurethane TPU | 264 | 8-1/32" (195) | 5-9/32" (134) | Precision Ball | PG-06PYP-125-TL-TP01 |
| 8 | 1-1/4 | Rubber on Plastic | 264 | 10-13/64" (251) | 5-29/32" (150) | Precision Ball | PG-08RPP-125-TL-TP01 |
| 8 | 1-1/4 | Polyurethane TPU | 264 | 10-13/64" (251) | 5-29/32" (150) | Precision Ball | PG-08PYP-125-TL-TP01 |



SWIVEL TOP PLATE DIRECTION LOCK MODELS

(LOCKS SWIVEL ONLY)

| Wheel Diameter (Inches) | Tread Width (Inches) | Wheel Description | Capacity (Lbs) | Load Height Inches (mm) | Swivel Radius Inches (mm) | Wheel Bearing | Model Number |
|-------------------------|----------------------|-------------------|----------------|-------------------------|---------------------------|----------------|----------------------|
| 4 | 1-1/4 | Rubber on Plastic | 220 | 5-23/32" (145) | 4-21/64" (110) | Precision Ball | PG-04RPP-125-DL-TP01 |
| 4 | 1-1/4 | Polyurethane TPU | 220 | 5-23/32" (145) | 4-21/64" (110) | Precision Ball | PG-04PYP-125-DL-TP01 |
| 5 | 1-1/4 | Rubber on Plastic | 220 | 6-9/16" (165) | 4-23/32" (120) | Precision Ball | PG-05RPP-125-DL-TP01 |
| 5 | 1-1/4 | Polyurethane TPU | 220 | 6-9/16" (165) | 4-23/32" (120) | Precision Ball | PG-05PYP-125-DL-TP01 |
| 6 | 1-1/4 | Rubber on Plastic | 264 | 8-1/32" (195) | 5-9/32" (134) | Precision Ball | PG-06RPP-125-DL-TP01 |
| 6 | 1-1/4 | Polyurethane TPU | 264 | 8-1/32" (195) | 5-9/32" (134) | Precision Ball | PG-06PYP-125-DL-TP01 |
| 8 | 1-1/4 | Rubber on Plastic | 264 | 10-13/64" (251) | 5-29/32" (150) | Precision Ball | PG-08RPP-125-DL-TP01 |
| 8 | 1-1/4 | Polyurethane TPU | 264 | 10-13/64" (251) | 5-29/32" (150) | Precision Ball | PG-08PYP-125-DL-TP01 |



Our Directional Lock casters are designed to lock the swivel but not the wheel allowing you to steer your equipment. The directional lock feature is designed to break free under heavier load when the unit is traversing a corner only to lock back into position when the unit resumes a straight course.

TOP PLATE FITTING

TP01
Swivel Top
Plate Pattern

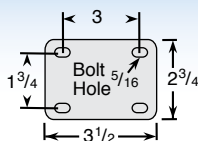

PLASTIC (PG)

HOLLOW KINGPIN MODELS

FREE SWIVEL • TOTAL LOCK • DIRECTION LOCK

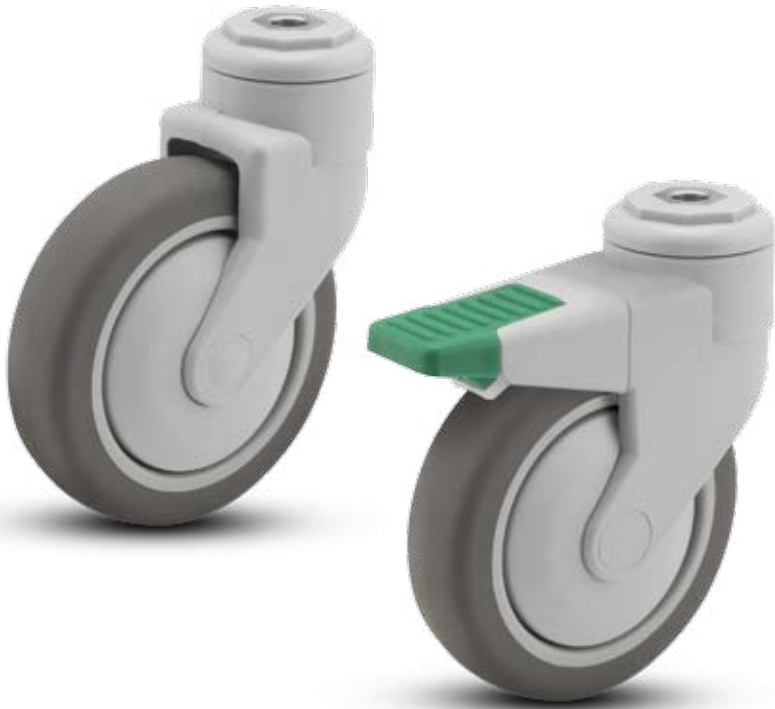

- APPLICATIONS**
- Food Service Equipment
 - Case Carts
 - Utility Carts
 - Medical Equipment
 - Institutional Equipment
 - Hospital Carts
 - Animal Cage Carts
 - Cart Washable applications

4", 5", 6"
& 8" wheel
diameters

- FEATURES**
- Maintenance free
 - Sealed precision bearing raceway
 - Total Lock Brake models lock both swivel and wheel
 - Directional lock models lock swivel only (helps with steering)
 - Wheel feature precision bearings and full thread guards
 - Rigs are made with glass filled nylon for added strength
 - Resistance to most chemicals
 - Recessed axle with plastic cap covers
 - Operating temperatures good to 210° F intermittent

Our PG series provides you with that smooth European look and design.

HOLLOW KINGPIN MODELS

| Wheel Diameter (Inches) | Tread Width (Inches) | Wheel Description | Capacity (Lbs) | Load Height Inches (mm) | Swivel Radius Inches (mm) | Wheel Bearing | Model Number |
|-------------------------|----------------------|-------------------|----------------|-------------------------|---------------------------|----------------|----------------------|
| 4 | 1-1/4 | Rubber on Plastic | 220 | 5-45/64" (145) | 3-15/32" (88) | Precision Ball | PG-04RPP-125-SW-HKU1 |
| 4 | 1-1/4 | Polyurethane TPU | 220 | 5-45/64" (145) | 3-15/32" (88) | Precision Ball | PG-04PYP-125-SW-HKU1 |
| 5 | 1-1/4 | Rubber on Plastic | 220 | 6-1/2" (165) | 4-5/6" (110) | Precision Ball | PG-05RPP-125-SW-HKU1 |
| 5 | 1-1/4 | Polyurethane TPU | 220 | 6-1/2" (165) | 4-5/6" (110) | Precision Ball | PG-05PYP-125-SW-HKU1 |
| 6 | 1-1/4 | Rubber on Plastic | 264 | 7-25/32" (197) | 4-57/64" (124) | Precision Ball | PG-06RPP-125-SW-HKU1 |
| 6 | 1-1/4 | Polyurethane TPU | 264 | 7-25/32" (197) | 4-57/64" (124) | Precision Ball | PG-06PYP-125-SW-HKU1 |
| 8 | 1-1/4 | Rubber on Plastic | 264 | 9-7/8" (251) | 6-9/16" (165) | Precision Ball | PG-08RPP-125-SW-HKU1 |
| 8 | 1-1/4 | Polyurethane TPU | 264 | 9-7/8" (251) | 6-9/16" (165) | Precision Ball | PG-08PYP-125-SW-HKU1 |



HOLLOW KINGPIN

Caster is provided unassembled to make it easy to add your choice of fitting. If you would like these assembled change from HKU1 to HK01. 1/2 I.D.

Please see fitting pages for stems that can be added to this series.



PLASTIC (PG)

HOLLOW KINGPIN MODELS

FREE SWIVEL • TOTAL LOCK • DIRECTION LOCK

HOLLOW KINGPIN TOTAL LOCK MODELS

(LOCKS WHEEL AND SWIVEL)

| Wheel Diameter (Inches) | Tread Width (Inches) | Wheel Description | Capacity (Lbs) | Load Height Inches (mm) | Swivel Radius Inches (mm) | Wheel Bearing | Model Number |
|-------------------------|----------------------|-------------------|----------------|-------------------------|---------------------------|----------------|----------------------|
| 4 | 1-1/4 | Rubber on Plastic | 220 | 5-45/64" (145) | 4-21/64" (110) | Precision Ball | PG-04RPP-125-TL-HKU1 |
| 4 | 1-1/4 | Polyurethane TPU | 220 | 5-45/64" (145) | 4-21/64" (110) | Precision Ball | PG-04PYP-125-TL-HKU1 |
| 5 | 1-1/4 | Rubber on Plastic | 220 | 6-1/2" (165) | 4-23/32" (120) | Precision Ball | PG-05RPP-125-TL-HKU1 |
| 5 | 1-1/4 | Polyurethane TPU | 220 | 6-1/2" (165) | 4-23/32" (120) | Precision Ball | PG-05PYP-125-TL-HKU1 |
| 6 | 1-1/4 | Rubber on Plastic | 264 | 7-25/32" (197) | 5-9/32" (134) | Precision Ball | PG-06RPP-125-TL-HKU1 |
| 6 | 1-1/4 | Polyurethane TPU | 264 | 7-25/32" (197) | 5-9/32" (134) | Precision Ball | PG-06PYP-125-TL-HKU1 |
| 8 | 1-1/4 | Rubber on Plastic | 264 | 9-7/8" (251) | 5-29/32" (150) | Precision Ball | PG-08RPP-125-TL-HKU1 |
| 8 | 1-1/4 | Polyurethane TPU | 264 | 9-7/8" (251) | 5-29/32" (150) | Precision Ball | PG-08PYP-125-TL-HKU1 |



HOLLOW KINGPIN DIRECTION LOCK MODELS

(LOCKS SWIVEL ONLY)

| Wheel Diameter (Inches) | Tread Width (Inches) | Wheel Description | Capacity (Lbs) | Load Height Inches (mm) | Swivel Radius Inches (mm) | Wheel Bearing | Model Number |
|-------------------------|----------------------|-------------------|----------------|-------------------------|---------------------------|----------------|----------------------|
| 4 | 1-1/4 | Rubber on Plastic | 220 | 5-45/64" (145) | 4-21/64" (110) | Precision Ball | PG-04RPP-125-DL-HKU1 |
| 4 | 1-1/4 | Polyurethane TPU | 220 | 5-45/64" (145) | 4-21/64" (110) | Precision Ball | PG-04PYP-125-DL-HKU1 |
| 5 | 1-1/4 | Rubber on Plastic | 220 | 6-1/2" (165) | 4-23/32" (120) | Precision Ball | PG-05RPP-125-DL-HKU1 |
| 5 | 1-1/4 | Polyurethane TPU | 220 | 6-1/2" (165) | 4-23/32" (120) | Precision Ball | PG-05PYP-125-DL-HKU1 |
| 6 | 1-1/4 | Rubber on Plastic | 264 | 7-25/32" (197) | 5-9/32" (134) | Precision Ball | PG-06RPP-125-DL-HKU1 |
| 6 | 1-1/4 | Polyurethane TPU | 264 | 7-25/32" (197) | 5-9/32" (134) | Precision Ball | PG-06PYP-125-DL-HKU1 |
| 8 | 1-1/4 | Rubber on Plastic | 264 | 9-7/8" (251) | 5-29/32" (150) | Precision Ball | PG-08RPP-125-DL-HKU1 |
| 8 | 1-1/4 | Polyurethane TPU | 264 | 9-7/8" (251) | 5-29/32" (150) | Precision Ball | PG-08PYP-125-DL-HKU1 |



Our Directional Lock casters are designed to lock the swivel but not the wheel allowing you to steer your equipment. The directional lock feature is designed to break free under heavier load when the unit is traversing a corner only to lock back into position when the unit resumes a straight course.

HOLLOW KINGPIN

Caster is provided unassembled to make it easy to add your choice of fitting. If you would like these assembled change from HKU1 to HK01. 1/2 I.D.

Please see fitting pages for stems that can be added to this series.

PLASTIC (PG)

GRIP RING STEM MODELS

FREE SWIVEL • TOTAL LOCK • DIRECTION LOCK

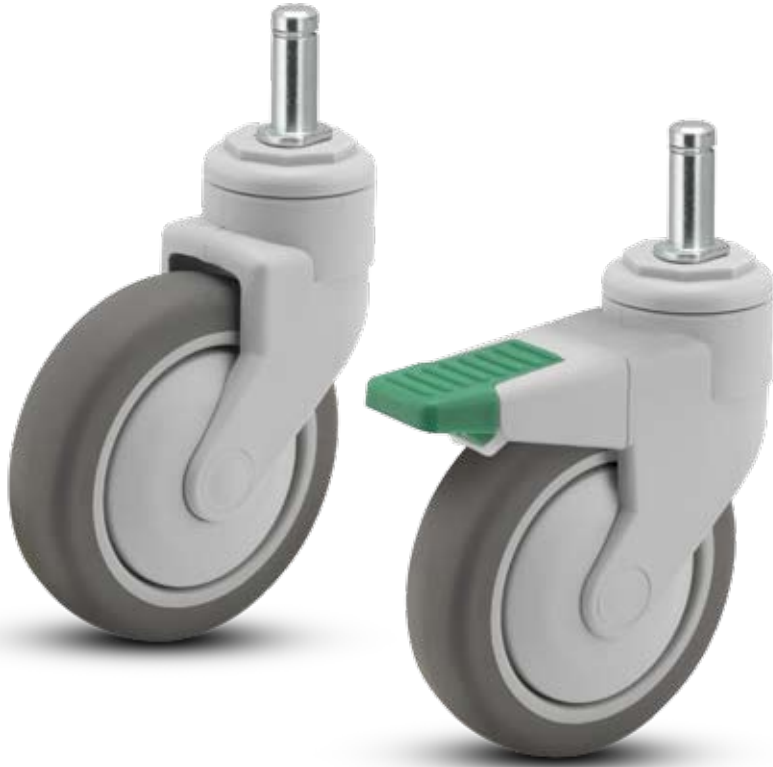

- ### APPLICATIONS
- Food Service Equipment
 - Case Carts
 - Utility Carts
 - Medical Equipment
 - Institutional Equipment
 - Hospital Carts
 - Animal Cage Carts
 - Cart Washable applications

4", 5", 6"
& 8" wheel
diameters

- ### FEATURES
- Maintenance free
 - Sealed precision bearing raceway
 - Total Lock Brake models lock both swivel and wheel
 - Directional lock models lock swivel only (helps with steering)
 - Wheel feature precision bearings and full thread guards
 - Rigs are made with glass filled nylon for added strength
 - Resistance to most chemicals
 - Recessed axle with plastic cap covers
 - Operating temperatures good to 210° F intermittent

Our PG series provides you with that smooth European look and design.

GRIP RING STEM MODELS

| Wheel Diameter (Inches) | Tread Width (Inches) | Wheel Description | Capacity (Lbs) | Load Height Inches (mm) | Swivel Radius Inches (mm) | Wheel Bearing | Model Number |
|-------------------------|----------------------|-------------------|----------------|-------------------------|---------------------------|----------------|---------------------|
| 4 | 1-1/4 | Rubber on Plastic | 220 | 5-45/64" (145) | 3-15/32" (88) | Precision Ball | PG-04RPP-125-SW-___ |
| 4 | 1-1/4 | Polyurethane TPU | 220 | 5-45/64" (145) | 3-15/32" (88) | Precision Ball | PG-04PYP-125-SW-___ |
| 5 | 1-1/4 | Rubber on Plastic | 220 | 6-1/2" (165) | 4-5/6" (110) | Precision Ball | PG-05RPP-125-SW-___ |
| 5 | 1-1/4 | Polyurethane TPU | 220 | 6-1/2" (165) | 4-5/6" (110) | Precision Ball | PG-05PYP-125-SW-___ |
| 6 | 1-1/4 | Rubber on Plastic | 264 | 7-25/32" (197) | 4-57/64" (124) | Precision Ball | PG-06RPP-125-SW-___ |
| 6 | 1-1/4 | Polyurethane TPU | 264 | 7-25/32" (197) | 4-57/64" (124) | Precision Ball | PG-06PYP-125-SW-___ |
| 8 | 1-1/4 | Rubber on Plastic | 264 | 9-7/8" (251) | 6-9/16" (165) | Precision Ball | PG-08RPP-125-SW-___ |
| 8 | 1-1/4 | Polyurethane TPU | 264 | 9-7/8" (251) | 6-9/16" (165) | Precision Ball | PG-08PYP-125-SW-___ |



GRIP RING STEM FITTINGS

Easy to install grip rings snap into place. See fittings page for more options.

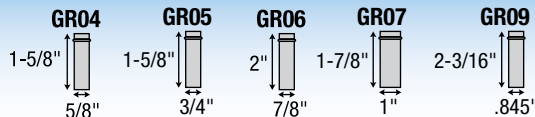

Specify Grip Ring Stem (GR) code, see fittings below for dimensions:

PLASTIC (PG)

GRIP RING STEM MODELS

FREE SWIVEL • TOTAL LOCK • DIRECTION LOCK

GRIP RING STEM TOTAL LOCK MODELS

(LOCKS WHEEL AND SWIVEL)

| Wheel Diameter (Inches) | Tread Width (Inches) | Wheel Description | Capacity (Lbs) | Load Height Inches (mm) | Swivel Radius Inches (mm) | Wheel Bearing | Model Number |
|-------------------------|----------------------|-------------------|----------------|-------------------------|---------------------------|----------------|---------------------|
| 4 | 1-1/4 | Rubber on Plastic | 220 | 5-45/64" (145) | 4-21/64" (110) | Precision Ball | PG-04RPP-125-TL-___ |
| 4 | 1-1/4 | Polyurethane TPU | 220 | 5-45/64" (145) | 4-21/64" (110) | Precision Ball | PG-04PYP-125-TL-___ |
| 5 | 1-1/4 | Rubber on Plastic | 220 | 6-1/2" (165) | 4-23/32" (120) | Precision Ball | PG-05RPP-125-TL-___ |
| 5 | 1-1/4 | Polyurethane TPU | 220 | 6-1/2" (165) | 4-23/32" (120) | Precision Ball | PG-05PYP-125-TL-___ |
| 6 | 1-1/4 | Rubber on Plastic | 264 | 7-25/32" (197) | 5-9/32" (134) | Precision Ball | PG-06RPP-125-TL-___ |
| 6 | 1-1/4 | Polyurethane TPU | 264 | 7-25/32" (197) | 5-9/32" (134) | Precision Ball | PG-06PYP-125-TL-___ |
| 8 | 1-1/4 | Rubber on Plastic | 264 | 9-7/8" (251) | 5-29/32" (150) | Precision Ball | PG-08RPP-125-TL-___ |
| 8 | 1-1/4 | Polyurethane TPU | 264 | 9-7/8" (251) | 5-29/32" (150) | Precision Ball | PG-08PYP-125-TL-___ |



GRIP RING STEM DIRECTION LOCK MODELS

(LOCKS SWIVEL ONLY)

| Wheel Diameter (Inches) | Tread Width (Inches) | Wheel Description | Capacity (Lbs) | Load Height Inches (mm) | Swivel Radius Inches (mm) | Wheel Bearing | Model Number |
|-------------------------|----------------------|-------------------|----------------|-------------------------|---------------------------|----------------|---------------------|
| 4 | 1-1/4 | Rubber on Plastic | 220 | 5-45/64" (145) | 4-21/64" (110) | Precision Ball | PG-04RPP-125-DL-___ |
| 4 | 1-1/4 | Polyurethane TPU | 220 | 5-45/64" (145) | 4-21/64" (110) | Precision Ball | PG-04PYP-125-DL-___ |
| 5 | 1-1/4 | Rubber on Plastic | 220 | 6-1/2" (165) | 4-23/32" (120) | Precision Ball | PG-05RPP-125-DL-___ |
| 5 | 1-1/4 | Polyurethane TPU | 220 | 6-1/2" (165) | 4-23/32" (120) | Precision Ball | PG-05PYP-125-DL-___ |
| 6 | 1-1/4 | Rubber on Plastic | 264 | 7-25/32" (197) | 5-9/32" (134) | Precision Ball | PG-06RPP-125-DL-___ |
| 6 | 1-1/4 | Polyurethane TPU | 264 | 7-25/32" (197) | 5-9/32" (134) | Precision Ball | PG-06PYP-125-DL-___ |
| 8 | 1-1/4 | Rubber on Plastic | 264 | 9-7/8" (251) | 5-29/32" (150) | Precision Ball | PG-08RPP-125-DL-___ |
| 8 | 1-1/4 | Polyurethane TPU | 264 | 9-7/8" (251) | 5-29/32" (150) | Precision Ball | PG-08PYP-125-DL-___ |



Our Directional Lock casters are designed to lock the swivel but not the wheel allowing you to steer your equipment. The directional lock feature is designed to break free under heavier load when the unit is traversing a corner only to lock back into position when the unit resumes a straight course.

GRIP RING STEM FITTINGS

Easy to install grip rings snap into place. See fittings page for more options.

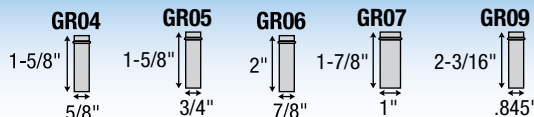

Specify Grip Ring Stem (GR) code, see fittings below for dimensions:

PLASTIC (PG)

THREADED STEM MODELS

FREE SWIVEL • TOTAL LOCK • DIRECTION LOCK



- APPLICATIONS**
- Food Service Equipment
 - Case Carts
 - Utility Carts
 - Medical Equipment
 - Institutional Equipment
 - Hospital Carts
 - Animal Cage Carts
 - Cart Washable applications

4", 5", 6"
& 8" wheel diameters

- FEATURES**
- Maintenance free
 - Sealed precision bearing raceway
 - Total Lock Brake models lock both swivel and wheel
 - Directional lock models lock swivel only (helps with steering)
 - Wheel feature precision bearings and full thread guards
 - Rigs are made with glass filled nylon for added strength
 - Resistance to most chemicals
 - Recessed axle with plastic cap covers
 - Operating temperatures good to 210° F intermittent

Our PG series provides you with that smooth European look and design.

THREADED STEM MODELS

| Wheel Diameter (Inches) | Tread Width (Inches) | Wheel Description | Capacity (Lbs) | Load Height Inches (mm) | Swivel Radius Inches (mm) | Wheel Bearing | Model Number |
|-------------------------|----------------------|-------------------|----------------|-------------------------|---------------------------|----------------|---------------------|
| 4 | 1-1/4 | Rubber on Plastic | 220 | 5-45/64" (145) | 3-15/32" (88) | Precision Ball | PG-04RPP-125-SW-___ |
| 4 | 1-1/4 | Polyurethane TPU | 220 | 5-45/64" (145) | 3-15/32" (88) | Precision Ball | PG-04PYP-125-SW-___ |
| 5 | 1-1/4 | Rubber on Plastic | 220 | 6-1/2" (165) | 4-5/6" (110) | Precision Ball | PG-05RPP-125-SW-___ |
| 5 | 1-1/4 | Polyurethane TPU | 220 | 6-1/2" (165) | 4-5/6" (110) | Precision Ball | PG-05PYP-125-SW-___ |
| 6 | 1-1/4 | Rubber on Plastic | 264 | 7-25/32" (197) | 4-57/64" (124) | Precision Ball | PG-06RPP-125-SW-___ |
| 6 | 1-1/4 | Polyurethane TPU | 264 | 7-25/32" (197) | 4-57/64" (124) | Precision Ball | PG-06PYP-125-SW-___ |
| 8 | 1-1/4 | Rubber on Plastic | 264 | 9-7/8" (251) | 6-9/16" (165) | Precision Ball | PG-08RPP-125-SW-___ |
| 8 | 1-1/4 | Polyurethane TPU | 264 | 9-7/8" (251) | 6-9/16" (165) | Precision Ball | PG-08PYP-125-SW-___ |



THREADED STEM FITTINGS

Easy to install stem. See fittings page for more options.



Specify Threaded Stem (TS) code, see fittings below for dimensions:

PLASTIC (PG)

THREADED STEM MODELS

FREE SWIVEL • TOTAL LOCK • DIRECTION LOCK

THREADED STEM TOTAL LOCK MODELS

(LOCKS WHEEL AND SWIVEL)

| Wheel Diameter (Inches) | Tread Width (Inches) | Wheel Description | Capacity (Lbs) | Load Height Inches (mm) | Swivel Radius Inches (mm) | Wheel Bearing | Model Number |
|-------------------------|----------------------|-------------------|----------------|-------------------------|---------------------------|----------------|--------------------|
| 4 | 1-1/4 | Rubber on Plastic | 220 | 5-45/64" (145) | 4-21/64" (110) | Precision Ball | PG-04RPP-125-TL-__ |
| 4 | 1-1/4 | Polyurethane TPU | 220 | 5-45/64" (145) | 4-21/64" (110) | Precision Ball | PG-04PYP-125-TL-__ |
| 5 | 1-1/4 | Rubber on Plastic | 220 | 6-1/2" (165) | 4-23/32" (120) | Precision Ball | PG-05RPP-125-TL-__ |
| 5 | 1-1/4 | Polyurethane TPU | 220 | 6-1/2" (165) | 4-23/32" (120) | Precision Ball | PG-05PYP-125-TL-__ |
| 6 | 1-1/4 | Rubber on Plastic | 264 | 7-25/32" (197) | 4-57/64" (124) | Precision Ball | PG-06RPP-125-TL-__ |
| 6 | 1-1/4 | Polyurethane TPU | 264 | 7-25/32" (197) | 4-57/64" (124) | Precision Ball | PG-06PYP-125-TL-__ |
| 8 | 1-1/4 | Rubber on Plastic | 264 | 9-7/8" (251) | 5-29/32" (150) | Precision Ball | PG-08RPP-125-TL-__ |
| 8 | 1-1/4 | Polyurethane TPU | 264 | 9-7/8" (251) | 5-29/32" (150) | Precision Ball | PG-08PYP-125-TL-__ |



THREADED STEM DIRECTION LOCK MODELS

(LOCKS SWIVEL ONLY)

| Wheel Diameter (Inches) | Tread Width (Inches) | Wheel Description | Capacity (Lbs) | Load Height Inches (mm) | Swivel Radius Inches (mm) | Wheel Bearing | Model Number |
|-------------------------|----------------------|-------------------|----------------|-------------------------|---------------------------|----------------|--------------------|
| 4 | 1-1/4 | Rubber on Plastic | 220 | 5-45/64" (145) | 4-21/64" (110) | Precision Ball | PG-04RPP-125-DL-__ |
| 4 | 1-1/4 | Polyurethane TPU | 220 | 5-45/64" (145) | 4-21/64" (110) | Precision Ball | PG-04PYP-125-DL-__ |
| 5 | 1-1/4 | Rubber on Plastic | 220 | 6-1/2" (165) | 4-15/16" (125) | Precision Ball | PG-05RPP-125-DL-__ |
| 5 | 1-1/4 | Polyurethane TPU | 220 | 6-1/2" (165) | 4-15/16" (125) | Precision Ball | PG-05PYP-125-DL-__ |
| 6 | 1-1/4 | Rubber on Plastic | 264 | 7-25/32" (197) | 4-23/32" (120) | Precision Ball | PG-06RPP-125-DL-__ |
| 6 | 1-1/4 | Polyurethane TPU | 264 | 7-25/32" (197) | 4-23/32" (120) | Precision Ball | PG-06PYP-125-DL-__ |
| 8 | 1-1/4 | Rubber on Plastic | 264 | 9-7/8" (251) | 5-29/32" (150) | Precision Ball | PG-08RPP-125-DL-__ |
| 8 | 1-1/4 | Polyurethane TPU | 264 | 9-7/8" (251) | 5-29/32" (150) | Precision Ball | PG-08PYP-125-DL-__ |



Our Directional Lock casters are designed to lock the swivel but not the wheel allowing you to steer your equipment. The directional lock feature is designed to break free under heavier load when the unit is traversing a corner only to lock back into position when the unit resumes a straight course.

Specify Threaded Stem (TS) code, see fittings below for dimensions:

THREADED STEM FITTINGS

Easy to install stem. See fittings page for more options.

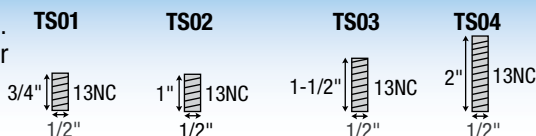

PLASTIC ANTISTATIC (PA)

TOP PLATE MODELS

FREE SWIVEL • TOTAL LOCK • DIRECTION LOCK



- APPLICATIONS**
- Computer equipment
 - Electronic Equipment
 - Case Carts
 - Utility Carts
 - Medical Equipment
 - Institutional Equipment
 - Hospital Carts
 - Cart Washable applications

- FEATURES**
- Sealed Precision Bearing raceway, smooth and quiet
 - Total Lock Brake models lock both swivel and wheel
 - Directional lock models lock swivel only (helps with Steering)
 - Wheel feature precision bearings and full thread guards
 - Resistance to most chemicals
 - Recessed axle with Yellow plastic cap covers
 - Maintenance Free
 - European style, Yellow chromate top plate

Molded electronically conductive polyamide housing is water proof and features precision ball bearings. Wheel and fork standard color is dark gray.

SWIVEL TOP PLATE MODELS

| Wheel Diameter (Inches) | Tread Width (Inches) | Wheel Description | Capacity (Lbs) | Load Height Inches (mm) | Swivel Radius Inches (mm) | Wheel Bearing | Model Number |
|-------------------------|----------------------|-------------------|----------------|-------------------------|---------------------------|----------------|----------------------|
| 4 | 1-1/4 | Antistatic Poly | 220 | 5-23/32" (145) | 3-15/32" (88) | Precision Ball | PA-04APP-125-SW-TP01 |
| 5 | 1-1/4 | Antistatic Poly | 220 | 6-9/16" (165) | 4-5/6" (110) | Precision Ball | PA-05APP-125-SW-TP01 |
| 6 | 1-1/4 | Antistatic Poly | 264 | 8-1/32" (195) | 4-57/64" (124) | Precision Ball | PA-06APP-125-SW-TP01 |
| 8 | 1-1/4 | Antistatic Poly | 264 | 10-13/64" (251) | 6-9/16" (165) | Precision Ball | PA-08APP-125-SW-TP01 |



SWIVEL TOP PLATE TOTAL LOCK MODELS

| | | | | | | | |
|---|-------|-----------------|-----|-----------------|----------------|----------------|----------------------|
| 4 | 1-1/4 | Antistatic Poly | 220 | 5-23/32" (145) | 4-21/64" (110) | Precision Ball | PA-04APP-125-TL-TP01 |
| 5 | 1-1/4 | Antistatic Poly | 220 | 6-9/16" (165) | 4-23/32" (120) | Precision Ball | PA-05APP-125-TL-TP01 |
| 6 | 1-1/4 | Antistatic Poly | 264 | 8-1/32" (195) | 5-9/32" (134) | Precision Ball | PA-06APP-125-TL-TP01 |
| 8 | 1-1/4 | Antistatic Poly | 264 | 10-13/64" (251) | 5-29/32" (150) | Precision Ball | PA-08APP-125-TL-TP01 |



SWIVEL TOP PLATE DIRECTION LOCK MODELS

(LOCKS SWIVEL ONLY)

| | | | | | | | |
|---|-------|-----------------|-----|-----------------|----------------|----------------|----------------------|
| 4 | 1-1/4 | Antistatic Poly | 220 | 5-23/32" (145) | 4-21/64" (110) | Precision Ball | PA-04APP-125-SW-TP01 |
| 5 | 1-1/4 | Antistatic Poly | 220 | 6-9/16" (165) | 4-23/32" (120) | Precision Ball | PA-05APP-125-SW-TP01 |
| 6 | 1-1/4 | Antistatic Poly | 264 | 8-1/32" (195) | 5-9/32" (134) | Precision Ball | PA-06APP-125-SW-TP01 |
| 8 | 1-1/4 | Antistatic Poly | 264 | 10-13/64" (251) | 5-29/32" (150) | Precision Ball | PA-08APP-125-SW-TP01 |



TOP PLATE FITTING

Swivel Top Plate Pattern

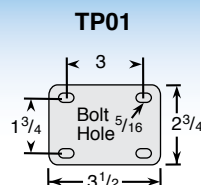

Our Directional Lock casters are designed to lock the swivel but not the wheel allowing you to steer your equipment. The directional lock feature is designed to break free under heavier load when the unit is traversing a corner only to lock back into position when the unit resumes a straight course.

Both the caster fork and wheel are electrically conductive. Caster conforms to CEN standards with resistance values < 10,000 ohms (measured at 500V DC, with minimum output of 50 V DC at 1,000 ohms resistance).

PLASTIC ANTISTATIC (PA)

THREADED STEM MODELS

FREE SWIVEL • TOTAL LOCK • DIRECTION LOCK

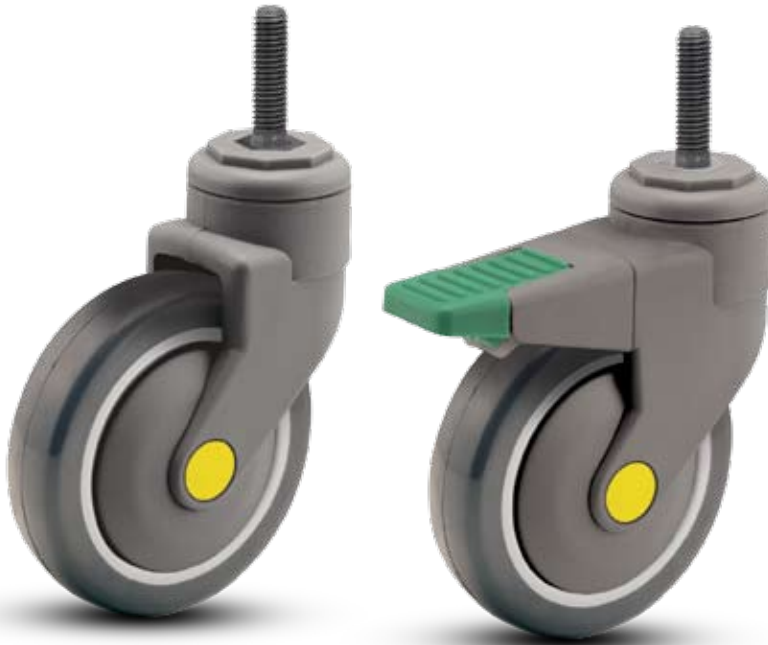

Hollow rivet models available. Consult factory.

- APPLICATIONS**
- Computer equipment
 - Electronic Equipment
 - Case Carts
 - Utility Carts
 - Medical Equipment
 - Institutional Equipment
 - Hospital Carts
 - Cart Washable applications

- FEATURES**
- Sealed Precision Bearing raceway, smooth and quiet
 - Total Lock Brake models lock both swivel and wheel
 - Directional lock models lock swivel only (helps with Steering)
 - Wheel feature precision bearings and full thread guards
 - Resistance to most chemicals
 - Recessed axle with Yellow plastic cap covers
 - Maintenance Free

Molded electronically conductive polyamide housing is water proof and features precision ball bearings. Wheel and fork standard color is dark gray.

THREADED STEM MODELS

| Wheel Diameter (Inches) | Tread Width (Inches) | Wheel Description | Capacity (Lbs) | Load Height Inches (mm) | Swivel Radius Inches (mm) | Wheel Bearing | Model Number |
|-------------------------|----------------------|-------------------|----------------|-------------------------|---------------------------|----------------|--------------------|
| 4 | 1-1/4 | Antistatic Poly | 220 | 5-45/64" (145) | 3-15/32" (88) | Precision Ball | PA-04APP-125-SW-__ |
| 5 | 1-1/4 | Antistatic Poly | 220 | 6-1/2" (165) | 4-5/6" (110) | Precision Ball | PA-05APP-125-SW-__ |
| 6 | 1-1/4 | Antistatic Poly | 264 | 7-25/32" (197) | 4-57/64" (124) | Precision Ball | PA-06APP-125-SW-__ |
| 8 | 1-1/4 | Antistatic Poly | 264 | 9-7/8" (251) | 6-9/16" (165) | Precision Ball | PA-08APP-125-SW-__ |



THREADED STEM TOTAL LOCK MODELS

(LOCKS WHEEL AND SWIVEL)

| | | | | | | | |
|---|-------|-----------------|-----|----------------|----------------|----------------|--------------------|
| 4 | 1-1/4 | Antistatic Poly | 220 | 5-45/64" (145) | 4-21/64" (110) | Precision Ball | PA-04APP-125-TL-__ |
| 5 | 1-1/4 | Antistatic Poly | 220 | 6-1/2" (165) | 4-23/32" (120) | Precision Ball | PA-05APP-125-TL-__ |
| 6 | 1-1/4 | Antistatic Poly | 264 | 7-25/32" (197) | 5-9/32" (134) | Precision Ball | PA-06APP-125-TL-__ |
| 8 | 1-1/4 | Antistatic Poly | 264 | 9-7/8" (251) | 5-9/32" (134) | Precision Ball | PA-08APP-125-TL-__ |



THREADED STEM DIRECTION LOCK MODELS

(LOCKS SWIVEL ONLY)

| | | | | | | | |
|---|-------|-----------------|-----|----------------|----------------|----------------|--------------------|
| 4 | 1-1/4 | Antistatic Poly | 220 | 5-45/64" (145) | 4-21/64" (110) | Precision Ball | PA-04APP-125-SW-__ |
| 5 | 1-1/4 | Antistatic Poly | 220 | 6-1/2" (165) | 4-23/32" (120) | Precision Ball | PA-05APP-125-SW-__ |
| 6 | 1-1/4 | Antistatic Poly | 264 | 7-25/32" (197) | 5-9/32" (134) | Precision Ball | PA-06APP-125-SW-__ |
| 8 | 1-1/4 | Antistatic Poly | 264 | 9-7/8" (251) | 5-9/32" (134) | Precision Ball | PA-08APP-125-SW-__ |



Our Directional Lock casters are designed to lock the swivel but not the wheel allowing you to steer your equipment. The directional lock feature is designed to break free under heavier load when the unit is traversing a corner only to lock back into position when the unit resumes a straight course.

Specify Threaded Stem (TS) code, see fittings below for dimensions:

THREADED STEM FITTINGS

Easy to install stem. See fittings page for more options.



Both the caster fork and wheel are electrically conductive. Caster conforms to CEN standards with resistance values < 10,000 ohms (measured at 500V DC, with minimum output of 50 V DC at 1,000 ohms resistance).

MEDCASTER BED CASTERS

MED-BED (MB)



New central lock
brake design

**HOSPITAL BED
PLASTIC (HP)**



Sturdy Nylon
Glass Filled

**HOSPITAL BED
STAINLESS (HS)**



304 Stainless Steel
Finish

**HOSPITAL BED
CHROME (HC)**



Attractive Chrome
Finish

**MED-BED
ULTRA (MU)**



Twin Wheel
Easy Turning in Tight
Spots

Typical Configurations for our Hospital bed Casters

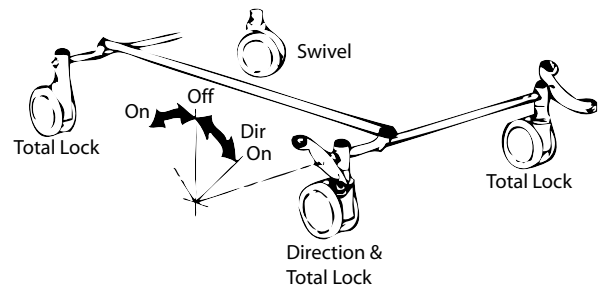
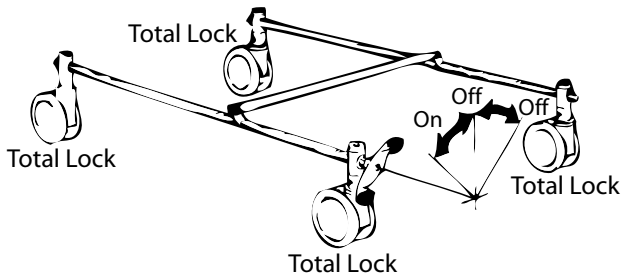

Bed System Caster Accessories



T3: double lever,
round profile



A1: double lever in
chrome, flat profile



C1: steel
adapter



B5:
adapter



B3: change
lever



B1: chrome
change lever

MED-BED (MB)

FREE SWIVEL • TOTAL LOCK •
TOTAL/DIRECTION LOCK COMBO



New 8" Wheel Diameter Model

APPLICATIONS

Anti-Microbial wheels available. Consult factory.

- ## FEATURES
- New 8" diameter models feature sealed precision ball raceway
 - Wheels have full plastic thread guards
 - Full double ball bearing raceways on 4" & 5" models
 - Very Positive swivel lock—operates independently of the wheel brake, reducing wear and tendency to ratchet
 - Precision ball bearings in wheels for easier rollability
 - Wheels are crowned for easy rolling and turning
 - Swivel rigs have a bright chrome finish
 - Cam-hole orientation to customer specification - can be in direction of travel, or 90 degrees to direction of travel.
 - Factory-set mechanism, maintenance-free for the life of the caster
 - Stem with 4 x M8 fixing holes to suit all bed layouts and reduce extra inventory needs.

Our new central locking brake design provides a more positive wheel lock with more surface contact on the wheel. Caster meets ISO Standard 22882: 2004 Casters & Wheels - Requirements for Casters for Hospital Beds.

CENTRAL LOCKING TOTAL LOCK

| Wheel Diameter Inches (mm) | Tread Width (Inches) | Wheel Description | Capacity (Lbs) | Load Height Inches (mm) | Swivel Radius Inches (mm) | Wheel Bearing | Model Number |
|----------------------------|----------------------|----------------------|----------------|-------------------------|---------------------------|----------------|---------------------|
| 4" (100) | 1-1/4 | Thermoplastic Rubber | 175 | 5-7/16" (138) | 3-15/32" (88) | Precision Ball | MB-04TPP-125-TL-___ |
| 5" (125) | 1-1/4 | Thermoplastic Rubber | 220 | 6-27/64"(163) | 3-37/64" (91) | Precision Ball | MB-05TPP-125-TL-___ |
| 8" (200) | 1-1/4 | Thermoplastic Rubber | 330 | 9-7/16" (240) | 6-3/8" (162) | Precision Ball | MB-08TPP-125-TL-___ |

CENTRAL LOCKING RUBBER DIRECTIONAL AND TOTAL LOCK COMBO

| | | | | | | | |
|----------|-------|----------------------|-----|---------------|---------------|----------------|---------------------|
| 4" (100) | 1-1/4 | Thermoplastic Rubber | 175 | 5-7/16" (138) | 3-15/32" (88) | Precision Ball | MB-04TPP-125-DT-___ |
| 5" (125) | 1-1/4 | Thermoplastic Rubber | 220 | 6-27/64"(163) | 3-37/64" (91) | Precision Ball | MB-05TPP-125-DT-___ |
| 8" (200) | 1-1/4 | Thermoplastic Rubber | 330 | 9-7/16" (240) | 6-3/8" (162) | Precision Ball | MB-08TPP-125-DT-___ |

FREE SWIVEL MODELS

| | | | | | | | |
|----------|-------|----------------------|-----|---------------|---------------|----------------|---------------------|
| 4" (100) | 1-1/4 | Thermoplastic Rubber | 175 | 5-7/16" (138) | 3-15/32" (88) | Precision Ball | MB-04TPP-125-SW-___ |
| 5" (125) | 1-1/4 | Thermoplastic Rubber | 220 | 6-27/64"(163) | 3-37/64" (91) | Precision Ball | MB-05TPP-125-SW-___ |
| 8" (200) | 1-1/4 | Thermoplastic Rubber | 330 | 9-7/16" (240) | 6-3/8" (162) | Precision Ball | MB-08TPP-125-DT-___ |

Locking Models

M8 threaded holes for fitting either in the direction of travel or 90 degrees to direction of travel

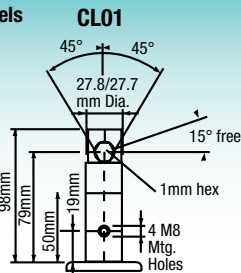

CL02

M6 threaded holes for fitting either in the direction of travel.

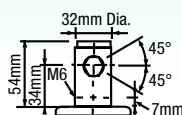

Free Swivel Models



27.8mm x 45mm for tubular frame with 28mm ID

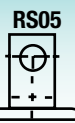

32mm x 54mm For tubular frame with 32mm ID

HOSPITAL BED PLASTIC (HP)

FREE SWIVEL • TOTAL LOCK • TOTAL/DIRECTION LOCK COMBO



APPLICATIONS

- Hospital Beds
- Stretchers

FEATURES

- Molded nylon with glass filler support
- Swivel, total lock and direction lock + total lock models available
- Available in grey finish
- Available with santoprene rubber, polyurethane and anti-static wheels
- Wheels are Non-marking
- Swivel raceway has sealed precision bearing for smooth easy swiveling
- Wheels are provided with sealed Precision bearing and full thread guards
- Resistant to many cleaning and disinfectant solutions
- M6 or M8 threaded holes for fitting either in the direction of travel or 90 degrees to direction of travel
- Cam holes are 90 degrees to direction of travel

HP hospital bed casters are molded nylon with glass filler support. Wheels and swivel feature precision bearing for smooth operation.

CENTRAL LOCKING FREE SWIVEL MODELS

| Wheel Diameter Inches (mm) | Tread Width (Inches) | Wheel Description | Capacity (Lbs) | Load Height Inches (mm) | Swivel Radius Inches (mm) | Wheel Bearing | Model Number |
|----------------------------|----------------------|-------------------|----------------|-------------------------|---------------------------|----------------|---------------------|
| 4" (100) | 1-1/4 | Rubber on Plastic | 198 | 5-45/64" (145) | 3-15/32" (88) | Precision Ball | HP-04RPP-125-SW-___ |
| 4" (100) | 1-1/4 | Polyurethane | 198 | 5-45/64" (145) | 3-15/32" (88) | Precision Ball | HP-04PYP-125-SW-___ |
| 5" (125) | 1-1/4 | Rubber on Plastic | 220 | 6-1/2" (165) | 4-5/16" (109) | Precision Ball | HP-05RPP-125-SW-___ |
| 5" (125) | 1-1/4 | Polyurethane | 220 | 6-1/2" (165) | 4-5/16" (109) | Precision Ball | HP-05PYP-125-SW-___ |
| 6" (150) | 1-1/4 | Rubber on Plastic | 220 | 7-43/64" (195) | 4-57/64" (124) | Precision Ball | HP-06RPP-125-SW-___ |
| 6" (150) | 1-1/4 | Polyurethane | 220 | 7-43/64" (195) | 4-57/64" (124) | Precision Ball | HP-06PYP-125-SW-___ |
| 8" (200) | 1-1/4 | Rubber on Plastic | 264 | 9-57/64" (251) | 6-37/64" (167) | Precision Ball | HP-08RPP-125-SW-___ |
| 8" (200) | 1-1/4 | Polyurethane | 264 | 9-57/64" (251) | 6-37/64" (167) | Precision Ball | HP-08PYP-125-SW-___ |

See total lock and direction lock models on next page

Free Swivel Models (Total/Direction next page)

RS03



27.8mm x 45mm for tubular frame with 28mm ID

RS05



32mm x 54mm For tubular frame with 32mm ID

HOSPITAL BED PLASTIC (HP)

FREE SWIVEL • TOTAL LOCK •
TOTAL/DIRECTION LOCK COMBO

CENTRAL LOCKING TOTAL LOCK MODELS

| Wheel Diameter Inches (mm) | Tread Width (Inches) | Wheel Description | Capacity (Lbs) | Load Height Inches (mm) | Swivel Radius Inches (mm) | Wheel Bearing | Model Number |
|----------------------------|----------------------|-------------------|----------------|-------------------------|---------------------------|----------------|----------------------|
| 4" (100) | 1-1/4 | Rubber on Plastic | 198 | 5-45/64" (145) | 3-15/32" (88) | Precision Ball | HP-04RPP-125-TL-____ |
| 4" (100) | 1-1/4 | Polyurethane | 198 | 5-45/64" (145) | 3-15/32" (88) | Precision Ball | HP-04PYP-125-TL-____ |
| 5" (125) | 1-1/4 | Rubber on Plastic | 220 | 6-1/2" (165) | 4-5/16" (109) | Precision Ball | HP-05RPP-125-TL-____ |
| 5" (125) | 1-1/4 | Polyurethane | 220 | 6-1/2" (165) | 4-5/16" (109) | Precision Ball | HP-05PYP-125-TL-____ |
| 6" (150) | 1-1/4 | Rubber on Plastic | 220 | 7-43/64" (195) | 4-57/64" (124) | Precision Ball | HP-06RPP-125-TL-____ |
| 6" (150) | 1-1/4 | Polyurethane | 220 | 7-43/64" (195) | 4-57/64" (124) | Precision Ball | HP-06PYP-125-TL-____ |
| 8" (200) | 1-1/4 | Rubber on Plastic | 264 | 9-57/64" (251) | 6-37/64" (167) | Precision Ball | HP-08RPP-125-TL-____ |
| 8" (200) | 1-1/4 | Polyurethane | 264 | 9-57/64" (251) | 6-37/64" (167) | Precision Ball | HP-08PYP-125-TL-____ |

CENTRAL LOCKING DIRECTIONAL AND TOTAL LOCK COMBO

| Wheel Diameter Inches (mm) | Tread Width (Inches) | Wheel Description | Capacity (Lbs) | Load Height Inches (mm) | Swivel Radius Inches (mm) | Wheel Bearing | Model Number |
|----------------------------|----------------------|-------------------|----------------|-------------------------|---------------------------|----------------|----------------------|
| 4" (100) | 1-1/4 | Rubber on Plastic | 198 | 5-45/64" (145) | 3-15/32" (88) | Precision Ball | HP-04RPP-125-DT-____ |
| 4" (100) | 1-1/4 | Polyurethane | 198 | 5-45/64" (145) | 3-15/32" (88) | Precision Ball | HP-04PYP-125-DT-____ |
| 5" (125) | 1-1/4 | Rubber on Plastic | 220 | 6-1/2" (165) | 4-5/16" (109) | Precision Ball | HP-05RPP-125-DT-____ |
| 5" (125) | 1-1/4 | Polyurethane | 220 | 6-1/2" (165) | 4-5/16" (109) | Precision Ball | HP-05PYP-125-DT-____ |
| 6" (150) | 1-1/4 | Rubber on Plastic | 220 | 7-43/64" (195) | 4-57/64" (124) | Precision Ball | HP-06RPP-125-DT-____ |
| 6" (150) | 1-1/4 | Polyurethane | 220 | 7-43/64" (195) | 4-57/64" (124) | Precision Ball | HP-06PYP-125-DT-____ |
| 8" (200) | 1-1/4 | Rubber on Plastic | 264 | 9-57/64" (251) | 6-37/64" (167) | Precision Ball | HP-08RPP-125-DT-____ |
| 8" (200) | 1-1/4 | Polyurethane | 264 | 9-57/64" (251) | 6-37/64" (167) | Precision Ball | HP-08PYP-125-DT-____ |

Locking Models

CL01

M8 threaded holes for fitting either in the direction of travel or 90 degrees to direction of travel

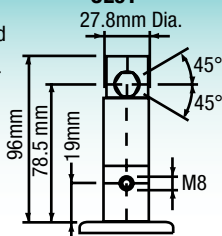

CL02

M6 threaded holes for fitting either in the direction of travel.

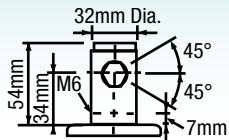

HOSPITAL BED CHROME (HC)

FREE SWIVEL • TOTAL LOCK • TOTAL/DIRECTION LOCK COMBO



APPLICATIONS

- Hospital Beds
- Stretchers

FEATURES

- Bright Chrome Finish
- Wheels are non-marking
- Swivel, total lock and direction lock + total lock models available
- Available with santoprene rubber, polyurethane and anti-static wheels
- Resistant to many cleaning and disinfectant solutions
- Swivel raceway has sealed precision bearing for smooth easy swiveling
- Wheels are provided with sealed precision bearings for easy rolling
- Wheels feature full thread Guards
- M8 threaded holes for fitting either in the direction of travel or 90 degrees to direction of travel

HC hospital bed chrome casters feature attractive bright chrome finish. Wheels and swivel feature precision bearing for smooth operation.

CENTRAL LOCKING FREE SWIVEL MODELS

| Wheel Diameter Inches (mm) | Tread Width (Inches) | Wheel Description | Capacity (Lbs) | Load Height (Inches) | Swivel Radius (Inches) | Wheel Bearing | Model Number |
|----------------------------|----------------------|--------------------------|----------------|----------------------|------------------------|----------------|---------------------|
| 4" (100) | 1-1/4 | Rubber on Plastic | 220 | 5-29/32" (150) | 3-45/64" (94) | Precision Ball | HC-04RPP-125-SW-___ |
| 4" (100) | 1-1/4 | Polyurethane | 220 | 5-29/32" (150) | 3-45/64" (94) | Precision Ball | HC-04PYP-125-SW-___ |
| 4" (100) | 1-1/4 | Polyurethane Anti-static | 220 | 5-29/32" (150) | 3-45/64" (94) | Precision Ball | HC-04APP-125-SW-___ |
| 5" (125) | 1-1/4 | Rubber on Plastic | 220 | 6-57/64" (175) | 4-15/64" (107) | Precision Ball | HC-05RPP-125-SW-___ |
| 5" (125) | 1-1/4 | Polyurethane | 220 | 6-57/64" (175) | 4-15/64" (107) | Precision Ball | HC-05PYP-125-SW-___ |
| 5" (125) | 1-1/4 | Polyurethane Anti-static | 220 | 6-57/64" (175) | 4-15/64" (107) | Precision Ball | HC-05APP-125-SW-___ |
| 6" (150) | 1-1/4 | Rubber on Plastic | 240 | 7-7/8" (200) | 4-31/32" (126) | Precision Ball | HC-06RPP-125-SW-___ |
| 6" (150) | 1-1/4 | Polyurethane | 240 | 7-7/8" (200) | 4-31/32" (126) | Precision Ball | HC-06PYP-125-SW-___ |
| 6" (150) | 1-1/4 | Polyurethane Anti-static | 240 | 7-7/8" (200) | 4-31/32" (126) | Precision Ball | HC-06APP-125-SW-___ |
| 8" (200) | 1-1/4 | Rubber on Plastic | 264 | 9-27/32" (250) | 6-1/16" (154) | Precision Ball | HC-08RPP-125-SW-___ |
| 8" (200) | 1-1/4 | Polyurethane | 264 | 9-27/32" (250) | 6-1/16" (154) | Precision Ball | HC-08PYP-125-SW-___ |
| 8" (200) | 1-1/4 | Polyurethane Anti-static | 264 | 9-27/32" (250) | 6-1/16" (154) | Precision Ball | HC-08APP-125-SW-___ |

See total lock and direction lock models on next page

Free Swivel Models (Total/Direction next page)

RS03



27.8mm x 45mm for tubular frame with 28mm ID

RS05



32mm x 54mm For tubular frame with 32mm ID

HOSPITAL BED CHROME (HC)

FREE SWIVEL • TOTAL LOCK •
TOTAL/DIRECTION LOCK COMBO

CENTRAL LOCKING TOTAL LOCK MODELS

| Wheel Diameter Inches (mm) | Tread Width (Inches) | Wheel Description | Capacity (Lbs) | Load Height (Inches) | Swivel Radius (Inches) | Wheel Bearing | Model Number |
|----------------------------|----------------------|--------------------------|----------------|----------------------|------------------------|----------------|-----------------------|
| 4" (100) | 1-1/4 | Rubber on Plastic | 220 | 5-29/32" (150) | 3-45/64" (94) | Precision Ball | HC-04RPP-125-TL-_____ |
| 4" (100) | 1-1/4 | Polyurethane | 220 | 5-29/32" (150) | 3-45/64" (94) | Precision Ball | HC-04PYP-125-TL-_____ |
| 4" (100) | 1-1/4 | Polyurethane Anti-static | 220 | 5-29/32" (150) | 3-45/64" (94) | Precision Ball | HC-04APP-125-TL-_____ |
| 5" (125) | 1-1/4 | Rubber on Plastic | 220 | 6-57/64" (175) | 4-15/64" (107) | Precision Ball | HC-05RPP-125-TL-_____ |
| 5" (125) | 1-1/4 | Polyurethane | 220 | 6-57/64" (175) | 4-15/64" (107) | Precision Ball | HC-05PYP-125-TL-_____ |
| 5" (125) | 1-1/4 | Polyurethane Anti-static | 220 | 6-57/64" (175) | 4-15/64" (107) | Precision Ball | HC-05APP-125-TL-_____ |
| 6" (150) | 1-1/4 | Rubber on Plastic | 240 | 7-7/8" (200) | 4-31/32" (126) | Precision Ball | HC-06RPP-125-TL-_____ |
| 6" (150) | 1-1/4 | Polyurethane | 240 | 7-7/8" (200) | 4-31/32" (126) | Precision Ball | HC-06PYP-125-TL-_____ |
| 6" (150) | 1-1/4 | Polyurethane Anti-static | 240 | 7-7/8" (200) | 4-31/32" (126) | Precision Ball | HC-06APP-125-TL-_____ |
| 8" (200) | 1-1/4 | Rubber on Plastic | 264 | 9-27/32" (250) | 6-1/16" (154) | Precision Ball | HC-08RPP-125-TL-_____ |
| 8" (200) | 1-1/4 | Polyurethane | 264 | 9-27/32" (250) | 6-1/16" (154) | Precision Ball | HC-08PYP-125-TL-_____ |
| 8" (200) | 1-1/4 | Polyurethane Anti-static | 264 | 9-27/32" (250) | 6-1/16" (154) | Precision Ball | HC-08APP-125-TL-_____ |

CENTRAL LOCKING DIRECTIONAL AND TOTAL LOCK COMBO

| Wheel Diameter Inches (mm) | Tread Width (Inches) | Wheel Description | Capacity (Lbs) | Load Height (Inches) | Swivel Radius (Inches) | Wheel Bearing | Model Number |
|----------------------------|----------------------|--------------------------|----------------|----------------------|------------------------|----------------|-----------------------|
| 4" (100) | 1-1/4 | Rubber on Plastic | 220 | 5-29/32" (150) | 3-45/64" (94) | Precision Ball | HC-04RPP-125-DT-_____ |
| 4" (100) | 1-1/4 | Polyurethane | 220 | 5-29/32" (150) | 3-45/64" (94) | Precision Ball | HC-04PYP-125-DT-_____ |
| 4" (100) | 1-1/4 | Polyurethane Anti-static | 220 | 5-29/32" (150) | 3-45/64" (94) | Precision Ball | HC-04APP-125-DT-_____ |
| 5" (125) | 1-1/4 | Rubber on Plastic | 220 | 6-57/64" (175) | 4-15/64" (107) | Precision Ball | HC-05RPP-125-DT-_____ |
| 5" (125) | 1-1/4 | Polyurethane | 220 | 6-57/64" (175) | 4-15/64" (107) | Precision Ball | HC-05PYP-125-DT-_____ |
| 5" (125) | 1-1/4 | Polyurethane Anti-static | 220 | 6-57/64" (175) | 4-15/64" (107) | Precision Ball | HC-05APP-125-DT-_____ |
| 6" (150) | 1-1/4 | Rubber on Plastic | 240 | 7-7/8" (200) | 4-31/32" (126) | Precision Ball | HC-06RPP-125-DT-_____ |
| 6" (150) | 1-1/4 | Polyurethane | 240 | 7-7/8" (200) | 4-31/32" (126) | Precision Ball | HC-06PYP-125-DT-_____ |
| 6" (150) | 1-1/4 | Polyurethane Anti-static | 240 | 7-7/8" (200) | 4-31/32" (126) | Precision Ball | HC-06APP-125-DT-_____ |
| 8" (200) | 1-1/4 | Rubber on Plastic | 264 | 9-27/32" (250) | 6-1/16" (154) | Precision Ball | HC-08RPP-125-DT-_____ |
| 8" (200) | 1-1/4 | Polyurethane | 264 | 9-27/32" (250) | 6-1/16" (154) | Precision Ball | HC-08PYP-125-DT-_____ |
| 8" (200) | 1-1/4 | Polyurethane Anti-static | 264 | 9-27/32" (250) | 6-1/16" (154) | Precision Ball | HC-08APP-125-DT-_____ |

Locking Models

M8 threaded holes for fitting either in the direction of travel or 90 degrees to direction of travel

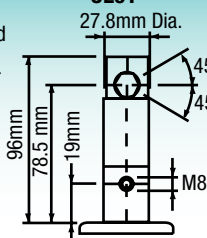

CL02

M6 threaded holes for fitting either in the direction of travel.

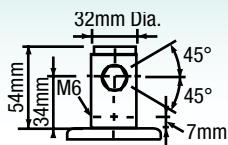

HOSPITAL BED STAINLESS (HS)

FREE SWIVEL • TOTAL LOCK • TOTAL/DIRECTION LOCK COMBO

APPLICATIONS

- Hospital Beds
- Stretchers

FEATURES

- Stainless Steel 304 Finish
- Wheels are Non-marking
- Swivel, total lock and direction lock + total lock models available
- Resistant to many cleaning and disinfectant solutions
- Wheels are provided with sealed precision bearings for easy rolling
- Wheels feature full thread guards
- Swivel raceway has sealed precision bearing for smooth easy swiveling
- Available with santoprene rubber, polyurethane and anti-static wheels
- Central Locking Stem and brake mechanism have Zinc Finish
- M8 threaded holes for fitting either in the direction of travel or 90 degrees to direction of travel



HS hospital bed chrome casters feature attractive 304 stainless steel. Wheels and swivel feature precision bearing for smooth operation.

CENTRAL LOCKING FREE SWIVEL MODELS

| Wheel Diameter Inches (mm) | Tread Width (Inches) | Wheel Description | Capacity (Lbs) | Load Height (Inches) | Swivel Radius (Inches) | Wheel Bearing | Model Number |
|----------------------------|----------------------|--------------------------|----------------|----------------------|------------------------|----------------|---------------------|
| 4" (100) | 1-1/4 | Rubber on Plastic | 220 | 5-29/32" (150) | 3-45/64" (94) | Precision Ball | HS-04RPP-125-SW-___ |
| 4" (100) | 1-1/4 | Polyurethane | 220 | 5-29/32" (150) | 3-45/64" (94) | Precision Ball | HS-04PYP-125-SW-___ |
| 4" (100) | 1-1/4 | Polyurethane Anti-static | 220 | 5-29/32" (150) | 3-45/64" (94) | Precision Ball | HS-04APP-125-SW-___ |
| 5" (125) | 1-1/4 | Rubber on Plastic | 220 | 6-57/64" (175) | 4-15/64" (107) | Precision Ball | HS-05RPP-125-SW-___ |
| 5" (125) | 1-1/4 | Polyurethane | 220 | 6-57/64" (175) | 4-15/64" (107) | Precision Ball | HS-05PYP-125-SW-___ |
| 5" (125) | 1-1/4 | Polyurethane Anti-static | 220 | 6-57/64" (175) | 4-15/64" (107) | Precision Ball | HS-05APP-125-SW-___ |
| 6" (150) | 1-1/4 | Rubber on Plastic | 240 | 7-7/8" (200) | 4-31/32" (126) | Precision Ball | HS-06RPP-125-SW-___ |
| 6" (150) | 1-1/4 | Polyurethane | 240 | 7-7/8" (200) | 4-31/32" (126) | Precision Ball | HS-06PYP-125-SW-___ |
| 6" (150) | 1-1/4 | Polyurethane Anti-static | 240 | 7-7/8" (200) | 4-31/32" (126) | Precision Ball | HS-06APP-125-SW-___ |
| 8" (200) | 1-1/4 | Rubber on Plastic | 264 | 9-27/32" (250) | 6-1/16" (154) | Precision Ball | HS-08RPP-125-SW-___ |
| 8" (200) | 1-1/4 | Polyurethane | 264 | 9-27/32" (250) | 6-1/16" (154) | Precision Ball | HS-08PYP-125-SW-___ |
| 8" (200) | 1-1/4 | Polyurethane Anti-static | 264 | 9-27/32" (250) | 6-1/16" (154) | Precision Ball | HS-08APP-125-SW-___ |

Free Swivel Models (Total/Direction next page)

RS03



27.8mm x 45mm for tubular frame with 28mm ID

RS05



32mm x 54mm For tubular frame with 32mm ID

See total lock and direction lock models on next page

HOSPITAL BED STAINLESS (HS)

FREE SWIVEL • TOTAL LOCK •
TOTAL/DIRECTION LOCK COMBO

CENTRAL LOCKING TOTAL LOCK MODELS

| Wheel Diameter Inches (mm) | Tread Width (Inches) | Wheel Description | Capacity (Lbs) | Load Height (Inches) | Swivel Radius (Inches) | Wheel Bearing | Model Number |
|----------------------------|----------------------|--------------------------|----------------|----------------------|------------------------|----------------|-----------------------|
| 4" (100) | 1-1/4 | Rubber on Plastic | 220 | 5-29/32" (150) | 3-45/64" (94) | Precision Ball | HS-04RPP-125-TL-_____ |
| 4" (100) | 1-1/4 | Polyurethane | 220 | 5-29/32" (150) | 3-45/64" (94) | Precision Ball | HS-04PYP-125-TL-_____ |
| 4" (100) | 1-1/4 | Polyurethane Anti-static | 220 | 5-29/32" (150) | 3-45/64" (94) | Precision Ball | HS-04APP-125-TL-_____ |
| 5" (125) | 1-1/4 | Rubber on Plastic | 220 | 6-57/64" (175) | 4-15/64" (107) | Precision Ball | HS-05RPP-125-TL-_____ |
| 5" (125) | 1-1/4 | Polyurethane | 220 | 6-57/64" (175) | 4-15/64" (107) | Precision Ball | HS-05PYP-125-TL-_____ |
| 5" (125) | 1-1/4 | Polyurethane Anti-static | 220 | 6-57/64" (175) | 4-15/64" (107) | Precision Ball | HS-05APP-125-TL-_____ |
| 6" (150) | 1-1/4 | Rubber on Plastic | 240 | 7-7/8" (200) | 4-31/32" (126) | Precision Ball | HS-06RPP-125-TL-_____ |
| 6" (150) | 1-1/4 | Polyurethane | 240 | 7-7/8" (200) | 4-31/32" (126) | Precision Ball | HS-06PYP-125-TL-_____ |
| 6" (150) | 1-1/4 | Polyurethane Anti-static | 240 | 7-7/8" (200) | 4-31/32" (126) | Precision Ball | HS-06APP-125-TL-_____ |
| 8" (200) | 1-1/4 | Rubber on Plastic | 264 | 9-27/32" (250) | 6-1/16" (154) | Precision Ball | HS-08RPP-125-TL-_____ |
| 8" (200) | 1-1/4 | Polyurethane | 264 | 9-27/32" (250) | 6-1/16" (154) | Precision Ball | HS-08PYP-125-TL-_____ |
| 8" (200) | 1-1/4 | Polyurethane Anti-static | 264 | 9-27/32" (250) | 6-1/16" (154) | Precision Ball | HS-08APP-125-TL-_____ |

CENTRAL LOCKING DIRECTIONAL AND TOTAL LOCK COMBO

| Wheel Diameter Inches (mm) | Tread Width (Inches) | Wheel Description | Capacity (Lbs) | Load Height (Inches) | Swivel Radius (Inches) | Wheel Bearing | Model Number |
|----------------------------|----------------------|--------------------------|----------------|----------------------|------------------------|----------------|-----------------------|
| 4" (100) | 1-1/4 | Rubber on Plastic | 220 | 5-29/32" (150) | 3-45/64" (94) | Precision Ball | HS-04RPP-125-DT-_____ |
| 4" (100) | 1-1/4 | Polyurethane | 220 | 5-29/32" (150) | 3-45/64" (94) | Precision Ball | HS-04PYP-125-DT-_____ |
| 4" (100) | 1-1/4 | Polyurethane Anti-static | 220 | 5-29/32" (150) | 3-45/64" (94) | Precision Ball | HS-04APP-125-DT-_____ |
| 5" (125) | 1-1/4 | Rubber on Plastic | 220 | 6-57/64" (175) | 4-15/64" (107) | Precision Ball | HS-05RPP-125-DT-_____ |
| 5" (125) | 1-1/4 | Polyurethane | 220 | 6-57/64" (175) | 4-15/64" (107) | Precision Ball | HS-05PYP-125-DT-_____ |
| 5" (125) | 1-1/4 | Polyurethane Anti-static | 220 | 6-57/64" (175) | 4-15/64" (107) | Precision Ball | HS-05APP-125-DT-_____ |
| 6" (150) | 1-1/4 | Rubber on Plastic | 240 | 7-7/8" (200) | 4-31/32" (126) | Precision Ball | HS-06RPP-125-DT-_____ |
| 6" (150) | 1-1/4 | Polyurethane | 240 | 7-7/8" (200) | 4-31/32" (126) | Precision Ball | HS-06PYP-125-DT-_____ |
| 6" (150) | 1-1/4 | Polyurethane Anti-static | 240 | 7-7/8" (200) | 4-31/32" (126) | Precision Ball | HS-06APP-125-DT-_____ |
| 8" (200) | 1-1/4 | Rubber on Plastic | 264 | 9-27/32" (250) | 6-1/16" (154) | Precision Ball | HS-08RPP-125-DT-_____ |
| 8" (200) | 1-1/4 | Polyurethane | 264 | 9-27/32" (250) | 6-1/16" (154) | Precision Ball | HS-08PYP-125-DT-_____ |
| 8" (200) | 1-1/4 | Polyurethane Anti-static | 264 | 9-27/32" (250) | 6-1/16" (154) | Precision Ball | HS-08APP-125-DT-_____ |

Locking Models

CL01

M8 threaded holes for fitting either in the direction of travel or 90 degrees to direction of travel

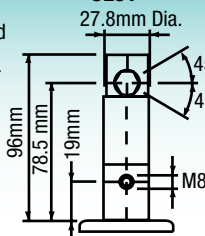

CL02

M6 threaded holes for fitting either in the direction of travel.

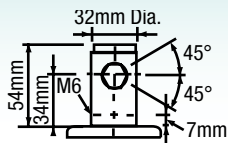

MED-ULTRA (MU)

FREE SWIVEL • TOTAL LOCK • TOTAL/DIRECTION LOCK COMBO



APPLICATIONS

- Hospital Beds
- Stretchers
- Ultrasonic Equipment

FEATURES

- Precision bearings in wheels
- Caster meets ISO Standard 22882: 2004 Caster & Wheels - Requirements for Casters for Hospital Beds.
- Central-locking brake design has very Positive swivel lock - operates independently of the wheel brake, reducing wear and tendency to ratchet
- Wheel brake can be applied dynamically without damage to mechanism.
- Factory-set mechanism, maintenance-free for the life of the caster
- Stem with 4 x M8 fixing holes to suit all bed layouts and reduce stock holding.

Dual wheel design improves turning. Our new central locking brake design provides a more positive wheel lock with more surface contact on the wheel. Caster meets ISO Standard 22882: 2004 Casters & Wheels - Requirements for Casters for Hospital Beds.

| Wheel Diameter Inches (mm) | Tread Width Inches (mm) | Wheel Description | Capacity (Lbs) | Load Height Inches (mm) | Swivel Lead Inches (mm) | Wheel Bearing | Model Number |
|------------------------------------------|-------------------------|--------------------------|----------------|-------------------------|-------------------------|----------------|---------------------|
| CENTRAL LOCKING TOTAL LOCK MODELS | | | | | | | |
| 5" (125) | 2-1/2"(65) | Polyurethane Gray | 352 | 6-1/64" (153) | 1-37/64" (40) | Precision Ball | MU-05PYP-283-TL-___ |
| 5" (125) | 2-1/2"(65) | Polyurethane Anti-Static | 352 | 6-1/64" (153) | 1-37/64" (40) | Precision Ball | MU-05APP-283-TL-___ |
| 6" (150) | 3-5/32"(80) | Polyurethane Gray | 484 | 7-1/16" (179) | 1-25/32" (45) | Precision Ball | MU-06PYP-283-TL-___ |
| 6" (150) | 3-5/32"(80) | Polyurethane Anti-Static | 484 | 7-1/16" (179) | 1-25/32" (45) | Precision Ball | MU-06APP-283-TL-___ |

CENTRAL LOCKING DIRECTIONAL AND TOTAL LOCK COMBO

| | | | | | | | |
|----------|-------------|--------------------------|-----|---------------|---------------|----------------|---------------------|
| 5" (127) | 2-1/2"(65) | Polyurethane Gray | 352 | 6-1/64" (153) | 1-37/64" (40) | Precision Ball | MU-05PYP-283-DT-___ |
| 5" (127) | 2-1/2"(65) | Polyurethane Anti-Static | 352 | 6-1/64" (153) | 1-37/64" (40) | Precision Ball | MU-05APP-283-DT-___ |
| 6" (150) | 3-5/32"(80) | Polyurethane Gray | 484 | 7-1/16" (179) | 1-25/32" (45) | Precision Ball | MU-06PYP-283-DT-___ |
| 6" (150) | 3-5/32"(80) | Polyurethane Anti-Static | 484 | 7-1/16" (179) | 1-25/32" (45) | Precision Ball | MU-06APP-283-DT-___ |

FREE SWIVEL MODELS

| | | | | | | | |
|----------|-------------|--------------------------|-----|---------------|---------------|----------------|---------------------|
| 5" (127) | 2-1/2"(65) | Polyurethane Gray | 352 | 6-1/64" (153) | 1-37/64" (40) | Precision Ball | MU-05PYP-283-SW-___ |
| 5" (127) | 2-1/2"(65) | Polyurethane Anti-Static | 352 | 6-1/64" (153) | 1-37/64" (40) | Precision Ball | MU-05APP-283-SW-___ |
| 6" (150) | 3-5/32"(80) | Polyurethane Gray | 484 | 7-1/16" (179) | 1-25/32" (45) | Precision Ball | MU-06PYP-283-SW-___ |
| 6" (150) | 3-5/32"(80) | Polyurethane Anti-Static | 484 | 7-1/16" (179) | 1-25/32" (45) | Precision Ball | MU-06APP-283-SW-___ |

Locking Models

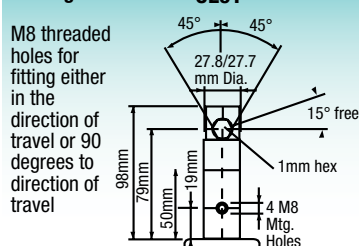

CL02

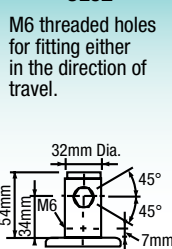

Free Swivel Models

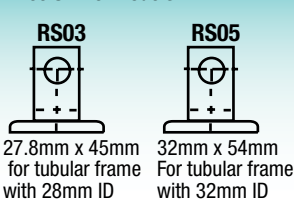

SOLUS TECH (ST)

FREE SWIVEL • TOTAL LOCK • DIRECTION LOCK



APPLICATIONS

- Medical and diagnostic equipment
- Computer equipment
- Electronic equipment
- High-tech products

Special colors available. Consult factory.

FEATURES

- Foot brake easily engaged; mechanically locks both swivel and wheel rotation
- Aluminum shell hides nuts and bolts
- Quiet operation
- Precision axle built to exacting tolerance for smooth operation and extended life
- Precision bearings reduce maintenance and improve maneuverability
- Choose from a wide variety of colors--minimum quantities required
- Polyurethane tires can be molded in a variety of colors, hardness
- Caster construction for non-magnetic characteristics
- Antistatic rubber, nylon, or polyurethane wheels

The unique shell design of the Solus Tech helps keep dirt out of the internal mechanism of the caster for a long service life. For routine maintenance, the outer shell can be removed from the caster for access to the internal braking mechanism.

FREE SWIVEL MODELS

| Wheel Diameter (Inches) | Tread Width (Inches) | Wheel Description | Capacity (lbs) | Load Height Inches (mm) | Swivel Lead Inches (mm) | Wheel Bearing | Model Number |
|-------------------------|----------------------|-------------------|----------------|-------------------------|-------------------------|----------------|----------------------|
| 4 | 1-15/32 | Polyurethane Gray | 175 | 5-19/32" (142) | 3-15/16" (100) | Precision Ball | ST-04PYP-150-SW-TS15 |
| 5 | 1-15/32 | Polyurethane Gray | 220 | 6-13/16" (173) | 4-15/16" (125) | Precision Ball | ST-05PYP-150-SW-TS16 |

TOTAL LOCK MODELS

| | | | | | | | |
|---|---------|-------------------|-----|----------------|----------------|----------------|----------------------|
| 4 | 1-15/32 | Polyurethane Gray | 175 | 5-19/32" (142) | 3-15/16" (100) | Precision Ball | ST-04PYP-150-TL-TS15 |
| 5 | 1-15/32 | Polyurethane Gray | 220 | 6-13/16" (173) | 4-15/16" (125) | Precision Ball | ST-05PYP-150-TL-TS16 |

DIRECTION LOCK MODELS

| | | | | | | | |
|---|---------|-------------------|-----|----------------|----------------|----------------|----------------------|
| 4 | 1-15/32 | Polyurethane Gray | 175 | 5-19/32" (142) | 3-15/16" (100) | Precision Ball | ST-04PYP-150-DL-TS15 |
| 5 | 1-15/32 | Polyurethane Gray | 220 | 6-13/16" (173) | 4-15/16" (125) | Precision Ball | ST-05PYP-150-DL-TS16 |

THREADED STEM FITTINGS

Easy to install stem. See fittings page for more options.

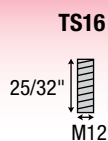
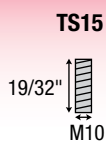

WHEELS

NEOTEQ (CN)



- **Tread:** Neoprene Rubber
- **Core:** Chrome Thread Guard
- **Temperature Range:** -30°F to +175°F
- **Hardness:** 70 (±5) Shore A

| Wheel Diameter (Inches) | Tread Width (Inches) | Capacity (Lbs) | Bearing | Fits Axle Size (Inches) | Model Number |
|-------------------------|----------------------|----------------|----------------|-------------------------|-----------------|
| 2 | 1 | 125 | Precision Ball | 5/16 | CN-02NRP-100-05 |
| 3 | 1 | 175 | Precision Ball | 5/16 | CN-03NRP-100-05 |

RAZER (RZ)

GREY TPR



- **Tread:** TPR
- **Side:** Metal Thread Guard
- **Temperature Range:** -30°F to +180°F
- **Hardness:** 85 (±5) Shore A

| Wheel Diameter (Inches) | Tread Width (Inches) | Capacity (Lbs) | Bearing | Fits Axle Size (Inches) | Model Number |
|-------------------------|----------------------|----------------|---------|-------------------------|-----------------|
| 2 | 3/4 | 110 | Plain | 5/16 | RZ-02TPN-070-05 |
| 3 | 7/8 | 140 | Ball | 5/16 | RZ-03TPP-090-05 |
| 4 | 7/8 | 160 | Ball | 5/16 | RZ-04TPP-090-05 |
| 5 | 7/8 | 165 | Ball | 5/16 | RZ-05TPP-090-05 |

CHROME HOSPITAL (CH), CHROME STEEL (CS), STAINLESS STEEL (SS)

THERMOPLASTIC RUBBER



- **Tread:** TPR
- **Side:** Plastic Thread Guard
- **Temperature Range:** -30°F to +210°F
- **Hardness:** 85 (±5) Shore A

| Wheel Diameter (Inches) | Tread Width (Inches) | Capacity (Lbs) | Bearing | Fits Axle Size (Inches) | Model Number |
|-------------------------|----------------------|----------------|----------------|-------------------------|-----------------|
| 3 | 1-1/4 | 165 | Precision Ball | 5/16 | CH-03TPP-125-05 |
| 4 | 1-1/4 | 190 | Precision Ball | 5/16 | CH-03TPP-125-05 |
| 5 | 1-1/4 | 220 | Precision Ball | 5/16 | CH-05TPP-125-05 |
| 6 | 1-1/4 | 240 | Precision Ball | 5/16 | CH-03TPP-125-05 |

ANTI-MICROBIAL TPR



- **Tread:** Anti-microbial TPR
- **Side:** Plastic Thread Guard
- **Temperature Range:** -30°F to +210°F
- **Hardness:** 85 (±5) Shore A

| Wheel Diameter (Inches) | Tread Width (Inches) | Capacity (Lbs) | Bearing | Fits Axle Size (Inches) | Model Number |
|-------------------------|----------------------|----------------|----------------|-------------------------|-----------------|
| 3 | 1-1/4 | 165 | Precision Ball | 5/16 | CH-03AMP-125-05 |
| 4 | 1-1/4 | 190 | Precision Ball | 5/16 | CH-04AMP-125-05 |
| 5 | 1-1/4 | 220 | Precision Ball | 5/16 | CH-05AMP-125-05 |
| 6 | 1-1/4 | 240 | Precision Ball | 5/16 | CH-06AMP-125-05 |

NEOPRENE RUBBER



- **Tread:** Neoprene
- **Side:** Plastic Thread Guard
- **Temperature Range:** -30°F to +175°F
- **Hardness:** 70 (±5) Shore A

| Wheel Diameter (Inches) | Tread Width (Inches) | Capacity (Lbs) | Bearing | Fits Axle Size (Inches) | Model Number |
|-------------------------|----------------------|----------------|----------------|-------------------------|-----------------|
| 4 | 1-1/4 | 250 | Precision Ball | 5/16 | CH-04NRP-125-05 |
| 4 | 1-1/4 | 250 | Precision Ball | 3/8 | CH-04NRP-125-06 |
| 5 | 1-1/4 | 300 | Precision Ball | 5/16 | CH-05NRP-125-05 |
| 5 | 1-1/4 | 300 | Precision Ball | 3/8 | CH-05NRP-125-06 |

POLYURETHANE TPU



- **Tread:** TPR Polyurethane
- **Side:** Plastic Thread Guard
- **Temperature Range:** -30°F to +180°F
- **Hardness:** 95 (±5) Shore A

| Wheel Diameter (Inches) | Tread Width (Inches) | Capacity (Lbs) | Bearing | Fits Axle Size (Inches) | Model Number |
|-------------------------|----------------------|----------------|----------------|-------------------------|-----------------|
| 3 | 1-1/4 | 165 | Precision Ball | 5/16 | CH-03TPP-125-05 |
| 4 | 1-1/4 | 190 | Precision Ball | 5/16 | CH-04TPP-125-05 |
| 5 | 1-1/4 | 220 | Precision Ball | 5/16 | CH-05TPP-125-05 |
| 6 | 1-1/4 | 240 | Precision Ball | 5/16 | CH-06TPP-125-05 |

WHEELS

NYLON (NG) AND NYLON PLUS STAINLESS (NS)

QUICKSTART TPR



- **Tread:** TPR
- **Side:** Integrated Thread Guard
- **Temperature Range:** -30°F to +180°F
- **Hardness:** 70 (±5) Shore A

| Wheel Diameter (Inches) | Tread Width (Inches) | Capacity (Lbs) | Bearing | Fits Axle Size (Inches) | Model Number |
|-------------------------|----------------------|----------------|----------------|-------------------------|-----------------|
| 3 | 1-1/4 | 200 | Precision Ball | 5/16 | NG-03QDP-125-05 |
| 4 | 1-1/4 | 275 | Precision Ball | 5/16 | NG-04QDP-125-05 |
| 5 | 1-1/4 | 325 | Precision Ball | 5/16 | NG-05QDP-125-05 |
| 6 | 1-1/4 | 325 | Precision Ball | 5/16 | NG-06QDP-125-05 |

ANTI-MICROBIAL TPR



- **Tread:** Antimicrobial TPR
- **Side:** Integrated Thread Guard
- **Temperature Range:** -30°F to +180°F
- **Hardness:** 70 (±5) Shore A

| Wheel Diameter (Inches) | Tread Width (Inches) | Capacity (Lbs) | Bearing | Fits Axle Size (Inches) | Model Number |
|-------------------------|----------------------|----------------|----------------|-------------------------|-----------------|
| 3 | 1-1/4 | 200 | Precision Ball | 5/16 | NG-03AMP-125-05 |
| 4 | 1-1/4 | 275 | Precision Ball | 5/16 | NG-04AMP-125-05 |
| 5 | 1-1/4 | 325 | Precision Ball | 5/16 | NG-05AMP-125-05 |
| 6 | 1-1/4 | 325 | Precision Ball | 5/16 | NG-06AMP-125-05 |

PLASTIC (PG)

RUBBER ON PLASTIC



- **Tread:** Rubber/Santoprene
- **Side:** Integrated Thread Guard
- **Temperature Range:** -30°F to +210°F
- **Hardness:** 85 (±5) Shore A

| Wheel Diameter (Inches) | Tread Width (Inches) | Capacity (Lbs) | Bearing | Fits Axle Size (Inches) | Model Number |
|-------------------------|----------------------|----------------|----------------|-------------------------|-----------------|
| 4 | 1-1/4 | 220 | Precision Ball | 5/16 | PG-04RPP-125-05 |
| 5 | 1-1/4 | 220 | Precision Ball | 5/16 | PG-05RPP-125-05 |
| 6 | 1-1/4 | 264 | Precision Ball | 5/16 | PG-06RPP-125-05 |
| 8 | 1-1/4 | 264 | Precision Ball | 5/16 | PG-08RPP-125-05 |

ANTI-STATIC PLASTIC (PA)

ANTI-STATIC POLYURETHANE TPU



- **Tread:** Polyurethane
- **Side:** Plastic Thread Guard
- **Temperature Range:** -30°F to +180°F
- **Hardness:** 95 (±5) Shore A

| Wheel Diameter (Inches) | Tread Width (Inches) | Capacity (Lbs) | Bearing | Fits Axle Size (Inches) | Model Number |
|-------------------------|----------------------|----------------|----------------|-------------------------|-----------------|
| 4 | 1-1/4 | 220 | Precision Ball | 5/16 | PA-04APP-125-05 |
| 5 | 1-1/4 | 220 | Precision Ball | 5/16 | PA-05APP-125-05 |
| 6 | 1-1/4 | 264 | Precision Ball | 5/16 | PA-06APP-125-05 |
| 8 | 1-1/4 | 264 | Precision Ball | 5/16 | PA-08APP-125-05 |

HOSPITAL BED REPLACEMENT WHEELS

HOSPITAL BED REPLACEMENT WHEELS (HP)

RUBBER ON PLASTIC



- **Tread:** Rubber
- **Side:** Integrated Thread Guard
- **Temperature Range:** -30°F to +160°F
- **Hardness:** 85 (±5) Shore A

| Wheel Diameter (Inches) | Tread Width (Inches) | Capacity (Lbs) | Bearing | Fits Axle Size (Inches) | Model Number |
|-------------------------|----------------------|----------------|----------------|-------------------------|-----------------|
| 4 | 1-1/4 | 198 | Precision Ball | 5/16 | HP-04RPP-125-05 |
| 5 | 1-1/4 | 220 | Precision Ball | 5/16 | HP-05RPP-125-05 |
| 6 | 1-1/4 | 220 | Precision Ball | 5/16 | HP-06RPP-125-05 |
| 8 | 1-1/4 | 264 | Precision Ball | 5/16 | HP-08RPP-125-05 |

POLYURETHANE



- **Tread:** Polyurethane
- **Side:** Integrated Thread Guard
- **Temperature Range:** -30°F to +180°F
- **Hardness:** 95 (±5) Shore A

| Wheel Diameter (Inches) | Tread Width (Inches) | Capacity (Lbs) | Bearing | Fits Axle Size (Inches) | Model Number |
|-------------------------|----------------------|----------------|----------------|-------------------------|-----------------|
| 4 | 1-1/4 | 198 | Precision Ball | 5/16 | HP-04PYP-125-05 |
| 5 | 1-1/4 | 220 | Precision Ball | 5/16 | HP-05PYP-125-05 |
| 6 | 1-1/4 | 220 | Precision Ball | 5/16 | HP-06PYP-125-05 |
| 8 | 1-1/4 | 264 | Precision Ball | 5/16 | HP-08PYP-125-05 |

HOSPITAL BED REPLACEMENT WHEELS (HC) AND (HS)

RUBBER ON PLASTIC



- **Tread:** Rubber
- **Side:** Bright Chrome Thread Guard
- **Temperature Range:** -30°F to +160°F
- **Hardness:** 85 (±5) Shore A

| Wheel Diameter (Inches) | Tread Width (Inches) | Capacity (Lbs) | Bearing | Fits Axle Size (Inches) | Model Number |
|-------------------------|----------------------|----------------|----------------|-------------------------|-----------------|
| 4 | 1-1/4 | 198 | Precision Ball | 5/16 | HC-04RPP-125-05 |
| 5 | 1-1/4 | 220 | Precision Ball | 5/16 | HC-05RPP-125-05 |
| 6 | 1-1/4 | 220 | Precision Ball | 5/16 | HC-06RPP-125-05 |
| 8 | 1-1/4 | 264 | Precision Ball | 5/16 | HC-08RPP-125-05 |

POLYURETHANE



- **Tread:** Polyurethane
- **Side:** Bright Chrome Thread Guard
- **Temperature Range:** -30°F to +180°F
- **Hardness:** 95 (±5) Shore A

| Wheel Diameter (Inches) | Tread Width (Inches) | Capacity (Lbs) | Bearing | Fits Axle Size (Inches) | Model Number |
|-------------------------|----------------------|----------------|----------------|-------------------------|-----------------|
| 4 | 1-1/4 | 198 | Precision Ball | 5/16 | HC-04PYP-125-05 |
| 5 | 1-1/4 | 220 | Precision Ball | 5/16 | HC-05PYP-125-05 |
| 6 | 1-1/4 | 220 | Precision Ball | 5/16 | HC-06PYP-125-05 |
| 8 | 1-1/4 | 264 | Precision Ball | 5/16 | HC-08PYP-125-05 |

POLYURETHANE ANTI-STATIC



- **Tread:** Polyurethane Anti-static (Yellow Dot)
- **Side:** Bright Chrome Thread Guard
- **Temperature Range:** -30°F to +180°F
- **Hardness:** 95 (±5) Shore A

| Wheel Diameter (Inches) | Tread Width (Inches) | Capacity (Lbs) | Bearing | Fits Axle Size (Inches) | Model Number |
|-------------------------|----------------------|----------------|----------------|-------------------------|-----------------|
| 4 | 1-1/4 | 198 | Precision Ball | 5/16 | HC-04APP-125-05 |
| 5 | 1-1/4 | 220 | Precision Ball | 5/16 | HC-05APP-125-05 |
| 6 | 1-1/4 | 220 | Precision Ball | 5/16 | HC-06APP-125-05 |
| 8 | 1-1/4 | 264 | Precision Ball | 5/16 | HC-08APP-125-05 |

WHEEL CHAIR CASTERS/WHEELS (WC) (WW)



APPLICATIONS

- Wheel chairs

Other sizes available. Consult factory

FEATURES

- New versatile chair replacement fork
- New front wheel chair wheels
- WC front wheel chair casters feature durable reinforced nylon construction
- Rear wheel chair casters now come in black or grey

VERSATILE FRONT WHEEL CHAIR REPLACEMENT FORK

| Description | Model Number |
|--------------------------------------------------------------------------------------------------------------------------------------------------------------------------------------------------------------------------------------------------------------------------|-----------------|
| Versatile durable light weight aluminum design fits wheels from 6" to 12" diameter wheels. Three holes allow you to choose the appropriate axle installation for desired wheel diameter. Designed for 2" tread width or less. 1/2" diameter threaded stem x 2-5/8" long. | WC-8200-SW-TS22 |



WHEEL CHAIR REPLACEMENT WHEELS

| Wheel Diameter Inches (mm) | Tread Width Inches (mm) | Wheel Description | Capacity (Lbs) | Wheel Bearing | Fits Axle Size (mm) | Model Number |
|----------------------------|-------------------------|--------------------|----------------|----------------|---------------------|-----------------|
| 6" (150) | 1-1/2" (38) | Black Polyurethane | 80 | Precision Ball | 8mm | WW-06PBP150-8M |
| 8" (200) | 1-1/2" (38) | Grey Polyurethane | 88 | Precision Ball | 8mm | WW-08PGP150-8M |
| 8" (200) | 2" (51) | Black Polyurethane | 88 | Precision Ball | 8mm | WW-08PBP200-8M |
| 12" (305) | 2" (51) | Grey Polyurethane | 132 | Precision Ball | 12mm | WW-12PGP200-12M |



WC FRONT WHEEL CHAIR CASTERS

| Wheel Diameter Inches (mm) | Tread Width Inches (mm) | Wheel Description | Capacity (Lbs) | Load Height Inches (mm) | Swivel Radius Inches (mm) | Wheel Bearing | Model Number |
|----------------------------|-------------------------|-------------------|----------------|-------------------------|---------------------------|---------------|---------------------|
| 7-1/2" (190) | 1-1/16" (27) | Polyurethane | 88 | 9-1/4" (235mm) | 5-1/2" (140mm) | Needle | WC-75PYR106-SW-TS17 |
| 7-7/8" (200) | 1-1/16" (27) | Polyurethane | 88 | 9-29/64" (240mm) | 5-3/4" (146mm) | Needle | WC-77PYR106-SW-TS17 |

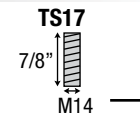

WHEEL CHAIR REAR

| Wheel Diameter Inches (mm) | Tread Width Inches (mm) | Wheel Description | Capacity (Lbs) | Hub Width Inches (mm) | Bore Size (mm) | Wheel Bearing | Model Number |
|----------------------------|-------------------------|-------------------|----------------|-----------------------|----------------|----------------|------------------|
| 24" (609) | 1-3/16" (30) | TPR Grey | 132 | 2-1/8" (54) | 12mm | Precision Ball | WW-024PBP118-12M |
| 24" (609) | 1-3/16" (30) | TPR Black | 132 | 2-1/8" (54) | 12mm | Precision Ball | WW-024PGP118-12M |



Available in black or grey. Consult factory.

BUMPERS

CORNER BUMPERS



A heavy duty bumper with an extra rounded build-up on the apex of the corner where shocks and wear are greatest. Ends are tapered and rounded. Each side is 3" long and 1¹/₈" wide at the base.

| Model Number | Thickness at Corner | Thickness at Ends | Mounting Holes |
|--------------|----------------------------------|-------------------|--------------------------------------------------|
| 6927 | 1 ⁵ / ₁₆ " | 1" | 2 (3 ³ / ₁₆ " on each side |

CORNER/ CONTINUOUS BUMPERS



Grey corner bumpers with matching strip bumpers provide 100% protection to the full perimeter of equipment. Strip bumpers are made with flat steel inserts for permanent attachment. Inserts in strip bumpers are not predrilled. They can be easily cut to size with a hacksaw and drilled as needed. Insert in corner bumper model 6926 is predrilled for mounting. Corner Bumper models 6905 and 6906 have no inserts. **Temperature Range:** -45°F to 180°F

| Model Number | Inserts | Length | | Width | Thickness | Mounting Holes |
|--------------|-----------------------|-------------------------------------------|----------------------------------|---------------------------------|-----------------------------------------------------------------|--------------------------------------------------------------------------------------------------|
| | | Long Side | Short Side | | | |
| 6926 | Insert Pre-drilled | 6 ³ / ₁₆ " | 3 ¹ / ₁₆ " | 1 ¹ / ₂ " | 1 ¹ / ₈ "-1 ³ / ₄ " | 2 (1 ⁷ / ₆₄ " in 6" side 1 (1 ⁷ / ₆₄ " in 3" side |
| 9.6930 | Insert | Specify (16 ft. max., 1ft. inc.) | | 1 ¹ / ₂ " | 1" | - |
| 66930 | No Insert | Specify (50 ft. max. 1ft. inc.) | | 1 ¹ / ₂ " | 1" | - |
| 6906 | No Insert | 2 ⁵ / ₈ " each side | | 1 ¹ / ₈ " | 1" | 2 (1 ³ / ₆₄ " each side |
| 9.6914 | Insert | Specify (16 ft. max. 1ft. inc.) | | 1 ¹ / ₈ " | 1" | - |
| 66914 | No Insert | Specify (50 ft. max. 1ft. inc.) | | 1 ¹ / ₈ " | 1" | - |
| 6905 | No Insert | 2 ¹ / ₂ " each side | | 3 ³ / ₄ " | 3 ³ / ₄ " | 2 (1 ¹ / ₈ " each side |
| 9.6913 | Insert | Specify (20 ft. max. 1ft. inc.) | | 3 ³ / ₄ " | 5 ⁵ / ₈ " | - |
| 66913 | No insert | Specify (50 ft. max. 1ft. inc.) | | 3 ³ / ₄ " | 5 ⁵ / ₈ " | - |

END BUMPERS



Generally used on the ends of tubular handles. Available in 3¹/₄" and 1³/₄" diameters. Easily attached, they are soft enough to absorb noise and shock and hard enough to wear for years.

| Model Number | Dia | Hole Dia. | Thickness |
|--------------|---------------------------------|----------------------------------|---------------------------------|
| 6901 | 3 ¹ / ₄ " | 1 ¹ / ₃₂ " | 7 ⁷ / ₈ " |
| 6901.01 | 1 ³ / ₄ " | 9 ⁹ / ₃₂ " | 1 ¹ / ₂ " |

SPECIALTY/CONVERSION

SPECIALTY PRODUCTS



Walker Casters and Wheels



Central Locking
Dual Wheel Caster



Streamline Medical Caster

MedCaster has a complete line of casters and wheels for the medical industry ... yet, sometimes you may need a unique solution for a caster or wheel that you cannot find. Contact us with your requirements.

INCHES TO MILLIMETERS CONVERSION

| Inches (Fraction) | Inches (Decimal) | Millimeters | Inches (Fraction) | Inches (Decimal) | Millimeters | Inches (Fraction) | Inches (Decimal) | Millimeters |
|-------------------|------------------|-------------|-------------------|------------------|-------------|-------------------|------------------|-------------|
| 1/64 | 0.02 | 0.40 | 1/2 | 0.50 | 12.69 | 1 | 1.00 | 25.38 |
| 1/32 | 0.03 | 0.79 | 33/64 | 0.52 | 13.09 | 2 | 2.00 | 50.76 |
| 3/64 | 0.05 | 1.19 | 17/32 | 0.53 | 13.48 | 3 | 3.00 | 76.14 |
| 1/16 | 0.06 | 1.59 | 35/64 | 0.55 | 13.88 | 4 | 4.00 | 101.52 |
| 5/64 | 0.08 | 1.98 | 9/16 | 0.56 | 14.28 | 5 | 5.00 | 126.90 |
| 3/32 | 0.09 | 2.38 | 37/64 | 0.58 | 14.67 | 6 | 6.00 | 152.28 |
| 7/64 | 0.11 | 2.78 | 19/32 | 0.59 | 15.07 | 7 | 7.00 | 177.66 |
| 1/8 | 0.13 | 3.17 | 39/64 | 0.61 | 15.47 | 8 | 8.00 | 203.05 |
| 9/64 | 0.14 | 3.57 | 5/8 | 0.63 | 15.86 | 12 | 12.00 | 304.57 |
| 5/32 | 0.16 | 3.97 | 41/64 | 0.64 | 16.26 | | | |
| 11/64 | 0.17 | 4.36 | 21/32 | 0.66 | 16.66 | | | |
| 3/16 | 0.19 | 4.76 | 43/64 | 0.67 | 17.05 | | | |
| 13/64 | 0.20 | 5.16 | 11/16 | 0.69 | 17.45 | | | |
| 7/32 | 0.22 | 5.55 | 45/64 | 0.70 | 17.85 | | | |
| 15/64 | 0.23 | 5.95 | 23/32 | 0.72 | 18.24 | | | |
| 1/4 | 0.25 | 6.35 | 47/64 | 0.73 | 18.64 | | | |
| 17/64 | 0.27 | 6.74 | 3/4 | 0.75 | 19.04 | | | |
| 9/32 | 0.28 | 7.14 | 49/64 | 0.77 | 19.43 | | | |
| 19/64 | 0.30 | 7.53 | 25/32 | 0.78 | 19.83 | | | |
| 5/16 | 0.31 | 7.93 | 51/64 | 0.80 | 20.23 | | | |
| 21/64 | 0.33 | 8.33 | 13/16 | 0.81 | 20.62 | | | |
| 11/32 | 0.34 | 8.72 | 53/64 | 0.83 | 21.02 | | | |
| 23/64 | 0.36 | 9.12 | 27/32 | 0.84 | 21.41 | | | |
| 3/8 | 0.38 | 9.52 | 55/64 | 0.86 | 21.81 | | | |
| 25/64 | 0.39 | 9.91 | 7/8 | 0.88 | 22.21 | | | |
| 13/32 | 0.41 | 10.31 | 57/64 | 0.89 | 22.60 | | | |
| 27/64 | 0.42 | 10.71 | 29/32 | 0.91 | 23.00 | | | |
| 7/16 | 0.44 | 11.10 | 59/64 | 0.92 | 23.40 | | | |
| 29/64 | 0.45 | 11.50 | 15/16 | 0.94 | 23.79 | | | |
| 15/32 | 0.47 | 11.90 | 61/64 | 0.95 | 24.19 | | | |
| 31/64 | 0.48 | 12.29 | 31/32 | 0.97 | 24.59 | | | |
| | | | 63/64 | 0.98 | 24.98 | | | |

- **Convert Inches to Millimeters:**
Divide by .0394 (note: this is how above chart was calculated and rounded to hundredths)
- **Convert Millimeters to Inches:**
Multiply by .0394.
- **Convert Kilograms to Pounds:**
Multiply by 2.2046.
- **Convert Pounds to Kilograms:**
Divide by 2.2046.